

Assembly Language Programming Lecture Notes

Delivered by
Belal Hashmi

Compiled by
Junaid Haroon

Preface

Assembly language programming develops a very basic and low level understanding of the computer. In higher level languages there is a distance between the computer and the programmer. This is because higher level languages are designed to be closer and friendlier to the programmer, thereby creating distance with the machine. This distance is covered by translators called compilers and interpreters. The aim of programming in assembly language is to bypass these intermediates and talk directly with the computer.

There is a general impression that assembly language programming is a difficult chore and not everyone is capable enough to understand it. The reality is in contrast, as assembly language is a very simple subject. The wrong impression is created because it is very difficult to realize that the real computer can be so simple. Assembly language programming gives a freehand exposure to the computer and lets the programmer talk with it in its language. The only translator that remains between the programmer and the computer is there to symbolize the computer's numeric world for the ease of remembering.

To cover the practical aspects of assembly language programming, IBM PC based on Intel architecture will be used as an example. However this course will not be tied to a particular architecture as it is often done. In our view such an approach does not create versatile assembly language programmers. The concepts of assembly language that are common across all platforms will be developed in such a manner as to emphasize the basic low level understanding of the computer instead of the peculiarities of one particular architecture. Emphasis will be more on assembly language and less on the IBM PC.

Before attempting this course you should know basic digital logic operations of AND, OR, NOT etc. You should know binary numbers and their arithmetic. Apart from these basic concepts there is nothing much you need to know before this course. In fact if you are not an expert, you will learn assembly language quickly, as non-experts see things with simplicity and the basic beauty of assembly language is that it is exceptionally simple. Do not ever try to find a complication, as one will not be there. In assembly language what is written in the program is all that is there, no less and no more.

After successful completion of this course, you will be able to explain all the basic operations of the computer and in essence understand the psychology of the computer. Having seen the computer from so close, you will understand its limitations and its capabilities. Your logic will become fine grained and this is one of the basic objectives of teaching assembly language programming.

Then there is the question that why should we learn assembly language when there are higher level languages one better than the other; C, C++, Java, to name just a few, with a neat programming environment and a simple way to write programs. Then why do we need such a freehand with the computer that may be dangerous at times? The answer to this lies in a very simple example. Consider a translator translating from English to Japanese. The problem faced by the translator is that every language has its own vocabulary and grammar. He may need to translate a word into a sentence and destroy the beauty of the topic. And given that we do not know

Japanese, so we cannot verify that our intent was correctly conveyed or not. Compiler is such a translator, just a lot dumber, and having a scarce number of words in its target language, it is bound to produce a lot of garbage and unnecessary stuff as a result of its ignorance of our program logic. In normal programs such garbage is acceptable and the ease of programming overrides the loss in efficiency but there are a few situations where this loss is unbearable.

Think about a four color picture scanned at 300 dots per inch making 90000 pixels per square inch. Now a processing on this picture requires 360000 operations per square inch, one operation for each color of each pixel. A few extra instructions placed by the translator can cost hours of extra time. The only way to optimize this is to do it directly in assembly language. But this doesn't mean that the whole application has to be written in assembly language, which is almost never the case. It's only the performance critical part that is coded in assembly language to gain the few extra cycles that matter at that point.

Consider an arch just like the ones in mosques. It cannot be made of big stones alone as that would make the arch wildly jagged, not like the fine arch we are used to see. The fine grains of cement are used to smooth it to the desired level of perfection. This operation of smoothing is optimization. The core structure is built in a higher level language with the big blocks it provides and the corners that need optimization are smoothed with the fine grain of assembly language which allows extreme control.

Another use of assembly language is in a class of time critical systems called real time systems. Real time systems have time bound responses, with an upper limit of time on certain operations. For such precise timing requirement, we must keep the instructions in our total control. In higher level languages we cannot even tell how many computer instructions were actually used, but in assembly language we can have precise control over them. Any reasonable sized application or a serious development effort has nooks and corners where assembly language is needed. And at these corners if there is no assembly language, there can be no optimization and when there is no optimization, there is no beauty. Sometimes a useful application becomes useless just because of the carelessness of not working on these jagged corners.

The third major reason for learning assembly language and a major objective for teaching it is to produce fine grained logic in programmers. Just like big blocks cannot produce an arch, the big thick grained logic learnt in a higher level language cannot produce the beauty and fineness assembly language can deliver. Each and every grain of assembly language has a meaning; nothing is presumed (e.g. div and mul for input and out put of decimal number). You have to put together these grains, the minimum number of them to produce the desired outcome. Just like a "for" loop in a higher level language is a block construct and has a hundred things hidden in it, but using the grains of assembly language we do a similar operation with a number of grains but in the process understand the minute logic hidden beside that simple "for" construct.

Assembly language cannot be learnt by reading a book or by attending a course. It is a language that must be tasted and enjoyed. There is no other way to learn it. You will need to try every example, observe and verify the things you are told about it, and experiment a lot with the computer. Only then you will know and become able to appreciate how powerful, versatile, and simple this language is; the three properties that are hardly ever present together.

Whether you program in C/C++ or Java, or in any programming paradigm be it object oriented or declarative, everything has to boil down to the bits and bytes of assembly language before the computer can even understand it.

Table of Contents

Preface	i
Table of Contents	iii
1 Introduction to Assembly Language	1
1.1. Basic Computer Architecture	1
1.2. Registers	3
1.3. Instruction Groups	5
1.4. Intel iapx88 Architecture	6
1.5. History	6
1.6. Register Architecture	7
1.7. Our First Program	9
1.8. Segmented Memory Model	12
2 Addressing Modes	17
2.1. Data Declaration	17
2.2. Direct Addressing	17
2.3. Size Mismatch Errors	21
2.4. Register Indirect Addressing	22
2.5. Register + Offset Addressing	25
2.6. Segment Association	25
2.7. Address Wraparound	26
2.8. Addressing Modes Summary	27
3 Branching	31
3.1. Comparison and Conditions	31
3.2. Conditional Jumps	33
3.3. Unconditional Jump	36
3.4. Relative Addressing	37
3.5. Types of Jump	37
3.6. Sorting Example	38
4 Bit Manipulations	43
4.1. Multiplication Algorithm	43
4.2. Shifting and Rotations	43
4.3. Multiplication in Assembly Language	46
4.4. Extended Operations	47
4.5. Bitwise Logical Operations	50
4.6. Masking Operations	51
5 Subroutines	55
5.1. Program Flow	55
5.2. Our First Subroutine	57
5.3. Stack	59
5.4. Saving and Restoring Registers	62
5.5. Parameter Passing Through Stack	64
5.6. Local Variables	67
6 Display Memory	71

6.1. ASCII Codes	71
6.2. Display Memory Formation	72
6.3. Hello World in Assembly Language	74
6.4. Number Printing in Assembly	76
6.5. Screen Location Calculation	79
7 String Instructions	83
7.1. String Processing	83
7.2. STOS Example – Clearing the Screen	85
7.3. LODS Example – String Printing	86
7.4. SCAS Example – String Length	87
7.5. LES and LDS Example	89
7.6. MOVS Example – Screen Scrolling	90
7.7. CMPS Example – String Comparison	92
8 Software Interrupts	95
8.1. Interrupts	95
8.2. Hooking an Interrupt	98
8.3. BIOS and DOS Interrupts	99
9 Real Time Interrupts and Hardware Interfacing	105
9.1. Hardware Interrupts	105
9.2. I/O Ports	106
9.3. Terminate and Stay Resident	111
9.4. Programmable Interval Timer	114
9.5. Parallel Port	116
10 Debug Interrupts	125
10.1. Debugger using single step interrupt	125
10.2. Debugger using breakpoint interrupt	128
11 Multitasking	131
11.1. Concepts of Multitasking	131
11.2. Elaborate Multitasking	133
11.3. Multitasking Kernel as TSR	135
12 Video Services	141
12.1. BIOS Video Services	141
12.2. DOS Video Services	144
13 Secondary Storage	147
13.1. Physical Formation	147
13.2. Storage Access Using BIOS	148
13.3. Storage Access using DOS	153
13.4. Device Drivers	158
14 Serial Port Programming	163
14.1. Introduction	163
14.2. Serial Communication	165
15 Protected Mode Programming	167
15.1. Introduction	167
15.2. 32bit Programming	170
15.3. VESA Linear Frame Buffer	172
15.4. Interrupt Handling	174
16 Interfacing with High Level Languages	179

16.1. Calling Conventions	179
16.2. Calling C from Assembly	179
16.3. Calling Assembly from C	181
17 Comparison with Other Processors	183

17.1. Motorola 68K Processors	183
17.2. Sun SPARC Processor	184

Introduction to Assembly Language

1.1. BASIC COMPUTER ARCHITECTURE

Address, Data, and Control Buses

A computer system comprises of a processor, memory, and I/O devices. I/O is used for interfacing with the external world, while memory is the processor's internal world. Processor is the core in this picture and is responsible for performing operations. The operation of a computer can be fairly described with processor and memory only. I/O will be discussed in a later part of the course. Now the whole working of the computer is performing an operation by the processor on data, which resides in memory.

The scenario that the processor executes operations and the memory contains data elements requires a mechanism for the processor to read that data from the memory. "That data" in the previous sentence much be rigorously explained to the memory which is a dumb device. Just like a postman, who must be told the precise address on the letter, to inform him where the destination is located. Another significant point is that if we only want to read the data and not write it, then there must be a mechanism to inform the memory that we are interested in reading data and not writing it. Key points in the above discussion are:

- There must be a mechanism to inform memory that we want to do the read operation
- There must be a mechanism to inform memory that we want to read precisely which element
- There must be a mechanism to transfer that data element from memory to processor

The group of bits that the processor uses to inform the memory about which element to read or write is collectively known as the *address bus*. Another important bus called the *data bus* is used to move the data from the memory to the processor in a read operation and from the processor to the memory in a write operation. The third group consists of miscellaneous independent lines used for control purposes. For example, one line of the bus is used to inform the memory about whether to do the read operation or the write operation. These lines are collectively known as the *control bus*.

These three buses are the eyes, nose, and ears of the processor. It uses them in a synchronized manner to perform a meaningful operation. Although the programmer specifies the meaningful operation, but to fulfill it the processor needs the collaboration of other units and peripherals. And that collaboration is made available using the three buses. This is the very basic description of a computer and it can be extended on the same lines to I/O but we are leaving it out just for simplicity for the moment.

The address bus is unidirectional and address always travels from processor to memory. This is because memory is a dumb device and cannot predict which element the processor at a particular instant of time needs. Data moves from both, processor to memory and memory to processor, so the data bus is bidirectional. Control bus is special and relatively complex, because different lines comprising it behave differently. Some take

information from the processor to a peripheral and some take information from the peripheral to the processor. There can be certain events outside the processor that are of its interest. To bring information about these events the data bus cannot be used as it is owned by the processor and will only be used when the processor grants permission to use it. Therefore certain processors provide control lines to bring such information to processor's notice in the control bus. Knowing these signals in detail is unnecessary but the general idea of the control bus must be conceived in full.

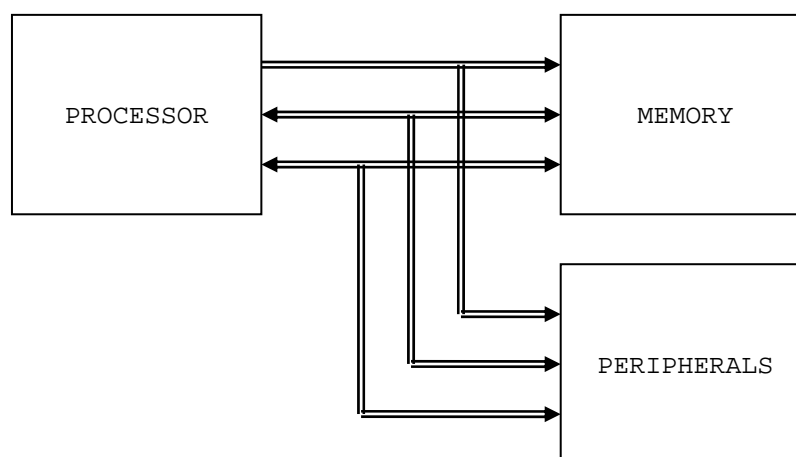

We take an example to explain the collaboration of the processor and memory using the address, control, and data buses. Consider that you want your uneducated servant to bring a book from the shelf. You order him to bring the fifth book from top of the shelf. All the data movement operations are hidden in this one sentence. Such a simple everyday phenomenon seen from this perspective explains the seemingly complex working of the three buses. We told the servant to “bring a book” and the one which is “fifth from top,” precise location even for the servant who is much more intelligent than our dumb memory. The dumb servant follows the steps one by one and the book is in your hand as a result. If however you just asked him for a book or you named the book, your uneducated servant will stand there gazing at you and the book will never come in your hand.

Even in this simplest of all examples, mathematics is there, “fifth from top.” Without a number the servant would not be able to locate the book. He is unable to understand your will. Then you tell him to put it with the seventh book on the right shelf. Precision is involved and only numbers are precise in this world. One will always be one and two will always be two. So we tell in the form of a number on the address bus which cell is needed out of say the 2000 cells in the whole memory.

A binary number is generated on the address bus, fifth, seventh, eighth, tenth; the cell which is needed. So the cell number is placed on the address bus. A memory cell is an n-bit location to store data, normally 8-bit also called a byte. The number of bits in a cell is called the *cell width*. The two dimensions, cell width and number of cells, define the memory completely just like the width and depth of a well defines it completely. 200 feet deep by 15 feet wide and the well is completely described. Similarly for memory we define two dimensions. The first dimension defines how many parallel bits are there in a single memory cell. The memory is called 8-bit or 16-bit for this reason and this is also the word size of the memory. This need not match the size of a processor word which has other parameters to define it. In general the memory cell cannot be wider than the width of the data bus. Best and simplest operation requires the same size of data bus and memory cell width.

Computer Architecture & Assembly Language Programming	Course Code: CS401
CS401@vu.edu.pk	VU

As we previously discussed that the control bus carries the intent of the processor that it wants to read or to write. Memory changes its behavior in response to this signal from the processor. It defines the direction of data flow. If processor wants to read but memory wants to write, there will be no communication or useful flow of information. Both must be synchronized, like a speaker speaks and the listener listens. If both speak simultaneously or both listen there will be no communication. This precise synchronization between the processor and the memory is the responsibility of the control bus.

Control bus is only the mechanism. The responsibility of sending the appropriate signals on the control bus to the memory is of the processor. Since the memory never wants to listen or to speak of itself. Then why is the control bus bidirectional. Again we take the same example of the servant and the book further to elaborate this situation. Consider that the servant went to fetch the book just to find that the drawing room door is locked. Now the servant can wait there indefinitely keeping us in surprise or come back and inform us about the situation so that we can act accordingly. The servant even though he was obedient was unable to fulfill our orders so in all his obedience, he came back to inform us about the problem. Synchronization is still important, as a result of our orders either we got the desired cell or we came to know that the memory is locked for the moment. Such information cannot be transferred via the address or the data bus. For such situations when peripherals want to talk to the processor when the processor wasn't expecting them to speak, special lines in the control bus are used. The information in such signals is usually to indicate the incapability of the peripheral to do something for the moment. For these reasons the control bus is a bidirectional bus and can carry information from processor to memory as well as from memory to processor.

1.2. REGISTERS

The basic purpose of a computer is to perform operations, and operations need operands. Operands are the data on which we want to perform a certain operation. Consider the addition operation; it involves adding two numbers to get their sum. We can have precisely one address on the address bus and consequently precisely one element on the data bus. At the very same instant the second operand cannot be brought inside the processor. As soon as the second is selected, the first operand is no longer there. For this reason there are temporary storage places inside the processor called *registers*. Now one operand can be read in a register and added into the other which is read directly from the memory. Both are made accessible at one instance of time, one from inside the processor and one from outside on the data bus. The result can be written to at a distinct location as the operation has completed and we can access a different memory cell. Sometimes we hold both operands in registers for the sake of efficiency as what we can do inside the processor is undoubtedly faster than if we have to go outside and bring the second operand.

Registers are like a scratch pad ram inside the processor and their operation is very much like normal memory cells. They have precise locations and remember what is placed inside them. They are used when we need more than one data element inside the processor at one time. The concept of registers will be further elaborated as we progress into writing our first program.

Memory is a limited resource but the number of memory cells is large. Registers are relatively very small in number, and are therefore a very scarce and precious resource. Registers are more than one in number, so we have to precisely identify or name them. Some manufacturers number their registers like r0, r1, r2, others name them like A, B, C, D etc. Naming is useful since the registers are few in number. This is called the nomenclature of the

Computer Architecture & Assembly Language Programming	Course Code: CS401
CS401@vu.edu.pk	VU

particular architecture. Still other manufacturers name their registers according to their function like X stands for an index register. This also informs us that there are special functions of registers as well, some of which are closely associated to the particular architecture. For example index registers do not hold data instead they are used to hold the address of data. There are other functions as well and the whole spectrum of register functionalities is quite large. However most of the details will become clear as the registers of the Intel architecture are discussed in detail.

Accumulator

There is a central register in every processor called the accumulator. Traditionally all mathematical and logical operations are performed on the accumulator. The word size of a processor is defined by the width of its accumulator. A 32bit processor has an accumulator of 32 bits.

Pointer, Index, or Base Register

The name varies from manufacturer to manufacturer, but the basic distinguishing property is that it does not hold data but holds the address of data. The rationale can be understood by examining a “for” loop in a higher level language, zeroing elements in an array of ten elements located in consecutive memory cells. The location to be zeroed changes every iteration. That is the address where the operation is performed is changing. Index register is used in such a situation to hold the address of the current array location. Now the value in the index register cannot be treated as data, but it is the address of data. In general whenever we need access to a memory location whose address is not known until runtime we need an index register. Without this register we would have needed to explicitly code each iteration separately.

In newer architectures the distinction between accumulator and index registers has become vague. They have general registers which are more versatile and can do both functions. They do have some specialized behaviors but basic operations can be done on all general registers.

Flags Register or Program Status Word

This is a special register in every architecture called the flags register or the program status word. Like the accumulator it is an 8, 16, or 32 bits register but unlike the accumulator it is meaningless as a unit, rather the individual bits carry different meanings. The bits of the accumulator work in parallel as a unit and each bit mean the same thing. The bits of the flags register work independently and individually, and combined its value is meaningless.

An example of a bit commonly present in the flags register is the carry flag. The carry can be contained in a single bit as in binary arithmetic the carry can only be zero or one. If a 16bit number is added to a 16bit accumulator, and the result is of 17 bits the 17th bit is placed in the carry bit of the flags register. Without this 17th bit the answer is incorrect. More examples of flags will be discussed when dealing with the Intel specific register set.

Program Counter or Instruction Pointer

Everything must translate into a binary number for our dumb processor to understand it, be it an operand or an operation itself. Therefore the instructions themselves must be translated into numbers. For example to add numbers we understand the word “add.” We translate this word into a number to make the processor understand it. This number is the actual instruction for the computer. All the objects, inheritance and encapsulation constructs in higher level languages translate down to just a number in assembly language in the end. Addition, multiplication, shifting; all big

Computer Architecture & Assembly Language Programming	Course Code: CS401
CS401@vu.edu.pk	VU

programs are made using these simple building blocks. A number is at the bottom line since this is the only thing a computer can understand.

A program is defined to be “an ordered set of instructions.” Order in this definition is a key part. Instructions run one after another, first, second, third and so on. Instructions have a positional relationship. The whole logic depends on this positioning. If the computer executes the fifth instructions after the first and not the second, all our logic is gone. The processor should ensure this ordering of instructions. A special register exists in every processor called the program counter or the instruction pointer that ensures this ordering. “The program counter holds the address of the next instruction to be executed.” A number is placed in the memory cell pointed to by this register and that number tells the processor which instruction to execute; for example 0xEA, 255, or 152. For the processor 152 might be the add instruction. Just this one number tells it that it has to add, where its operands are, and where to store the result. This number is called the *opcode*. The instruction pointer moves from one opcode to the next. This is how our program executes and progresses. One instruction is picked, its operands are read and the instruction is executed, then the next instruction is picked from the new address in instruction pointer and so on.

Remembering 152 for the add operation or 153 for the subtract operation is difficult. To make a simple way to remember difficult things we associate a symbol to every number. As when we write “add” everyone understands what we mean by it. Then we need a small program to convert this “add” of ours to 152 for the processor. Just a simple search and replace operation to translate all such symbols to their corresponding opcodes. We have mapped the numeric world of the processor to our symbolic world. “Add” conveys a meaning to us but the number 152 does not. We can say that add is closer to the programmer’s thinking. This is the basic motive of adding more and more translation layers up to higher level languages like C++ and Java and Visual Basic. These symbols are called *instruction mnemonics*. Therefore the mnemonic “add a to b” conveys more information to the reader. The dumb translator that will convert these mnemonics back to the original opcodes is a key program to be used throughout this course and is called the *assembler*.

1.3. INSTRUCTION GROUPS

Usual opcodes in every processor exist for moving data, arithmetic and logical manipulations etc. However their mnemonics vary depending on the will of the manufacturer. Some manufacturers name the mnemonics for data movement instructions as “move,” some call it “load” and “store” and still other names are present. But the basic set of instructions is similar in every processor. A grouping of these instructions makes learning a new processor quick and easy. Just the group an instruction belongs tells a lot about the instruction.

Data Movement Instructions

These instructions are used to move data from one place to another. These places can be registers, memory, or even inside peripheral devices. Some examples are:

```
mov ax, bx
lad 1234
```

Arithmetic and Logic Instructions

Arithmetic instructions like addition, subtraction, multiplication, division and Logical instructions like logical and, logical or, logical xor, or complement are part of this group. Some examples are:

```
and ax, 1234
add bx, 0534
add bx, [1200]
```

Computer Architecture & Assembly Language Programming	Course Code: CS401
CS401@vu.edu.pk	VU

The bracketed form is a complex variation meaning to add the data placed at address 1200. Addressing data in memory is a detailed topic and is discussed in the next chapter.

Program Control Instructions

The instruction pointer points to the next instruction and instructions run one after the other with the help of this register. We can say that the instructions are tied with one another. In some situations we don't want to follow this implied path and want to order the processor to break its flow if some condition becomes true instead of the spatially placed next instruction. In certain other cases we want the processor to first execute a separate block of code and then come back to resume processing where it left.

These are instructions that control the program execution and flow by playing with the instruction pointer and altering its normal behavior to point to the next instruction. Some examples are:

```
cmp ax, 0
jne 1234
```

We are changing the program flow to the instruction at 1234 address if the condition that we checked becomes true.

Special Instructions

Another group called special instructions works like the special service commandos. They allow changing specific processor behaviors and are used to play with it. They are used rarely but are certainly used in any meaningful program. Some examples are:

```
cli
sti
```

Where cli clears the interrupt flag and sti sets it. Without delving deep into it, consider that the cli instruction instructs the processor to close its ears from the outside world and never listen to what is happening outside, possibly to do some very important task at hand, while sti restores normal behavior. Since these instructions change the processor behavior they are placed in the special instructions group.

1.4. INTEL IAPX88 ARCHITECTURE

Now we select a specific architecture to discuss these abstract ideas in concrete form. We will be using IBM PC based on Intel architecture because of its wide availability, because of free assemblers and debuggers available for it, and because of its wide use in a variety of domains. However the concepts discussed will be applicable on any other architecture as well; just the mnemonics of the particular language will be different.

Technically iAPX88 stands for "Intel Advanced Processor Extensions 88." It was a very successful processor also called 8088 and was used in the very first IBM PC machines. Our discussion will revolve around 8088 in the first half of the course while in the second half we will use iAPX386 which is very advanced and powerful processor. 8088 is a 16bit processor with its accumulator and all registers of 16 bits. 386 on the other hand, is a 32bit processor. However it is downward compatible with iAPX88 meaning that all code written for 8088 is valid on the 386. The architecture of a processor means the organization and functionalities of the registers it contains and the instructions that are valid on the processor. We will discuss the register architecture of 8088 in detail below while its instructions are discussed in the rest of the book at appropriate places.

1.5. HISTORY

Intel did release some 4bit processors in the beginning but the first meaningful processor was 8080, an 8bit processor. The processor became

popular due to its simplistic design and versatile architecture. Based on the experience gained from 8080, an advanced version was released as 8085. The processor became widely popular in the engineering community again due to its simple and logical nature.

Intel introduced the first 16bit processor named 8088 at a time when the concept of personal computer was evolving. With a maximum memory of 64K on the 8085, the 8088 allowed a whole mega byte. IBM embedded this processor in their personal computer. The first machines ran at 4.43 MHz; a blazing speed at that time. This was the right thing at the right moment. No one expected this to become the biggest success of computing history. IBM PC XT became so popular and successful due to its open architecture and easily available information.

The success was unexpected for the developers themselves. As when Intel introduced the processor it contained a timer tick count which was valid for five years only. They never anticipated the architecture to stay around for more than five years but the history took a turn and the architecture is there at every desk even after 25 years and the tick is to be specially handled every now and then.

1.6. REGISTER ARCHITECTURE

The iAPX88 architecture consists of 14 registers.

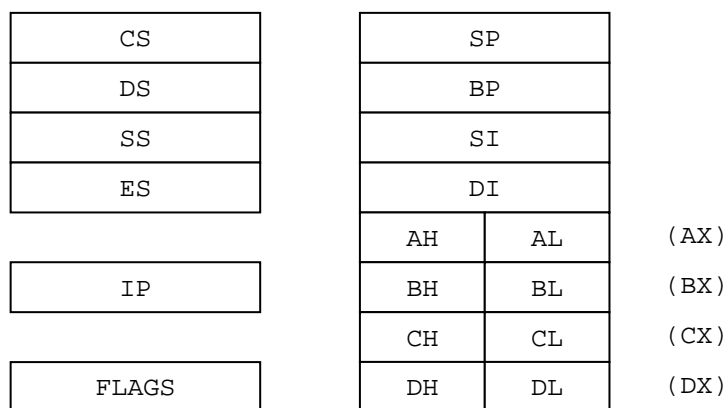

General Registers (AX, BX, CX, and DX)

The registers AX, BX, CX, and DX behave as general purpose registers in Intel architecture and do some specific functions in addition to it. X in their names stand for extended meaning 16bit registers. For example AX means we are referring to the extended 16bit "A" register. Its upper and lower byte are separately accessible as AH (A high byte) and AL (A low byte). All general purpose registers can be accessed as one 16bit register or as two 8bit registers. The two registers AH and AL are part of the big whole AX. Any change in AH or AL is reflected in AX as well. AX is a composite or extended register formed by gluing together the two parts AH and AL.

The A of AX stands for Accumulator. Even though all general purpose registers can act as accumulator in most instructions there are some specific variations which can only work on AX which is why it is named the accumulator. The B of BX stands for Base because of its role in memory addressing as discussed in the next chapter. The C of CX stands for Counter as there are certain instructions that work with an automatic count in the CX register. The D of DX stands for Destination as it acts as the destination in I/O operations. The A, B, C, and D are in letter sequence as well as depict some special functionality of the register.

Index Registers (SI and DI)

SI and DI stand for source index and destination index respectively. These are the index registers of the Intel architecture which hold address of data and used in memory access. Being an open and flexible architecture, Intel allows many mathematical and logical operations on these registers as well like the general registers. The source and destination are named because of their implied functionality as the source or the destination in a special class of instructions called the string instructions. However their use is not at all restricted to string instructions. SI and DI are 16bit and cannot be used as 8bit register pairs like AX, BX, CX, and DX.

Instruction Pointer (IP)

This is the special register containing the address of the next instruction to be executed. No mathematics or memory access can be done through this register. It is out of our direct control and is automatically used. Playing with it is dangerous and needs special care. Program control instructions change the IP register.

Stack Pointer (SP)

It is a memory pointer and is used indirectly by a set of instructions. This register will be explored in the discussion of the system stack.

Base Pointer (BP)

It is also a memory pointer containing the address in a special area of memory called the stack and will be explored alongside SP in the discussion of the stack.

Flags Register

The flags register as previously discussed is not meaningful as a unit rather it is bit wise significant and accordingly each bit is named separately. The bits not named are unused. The Intel FLAGS register has its bits organized as follows:

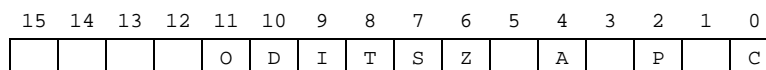

The individual flags are explained in the following table.

C	Carry	When two 16bit numbers are added the answer can be 17 bits long or when two 8bit numbers are added the answer can be 9 bits long. This extra bit that won't fit in the target register is placed in the carry flag where it can be used and tested.
P	Parity	Parity is the number of "one" bits in a binary number. Parity is either odd or even. This information is normally used in communications to verify the integrity of data sent from the sender to the receiver.
A	Auxiliary Carry	A number in base 16 is called a hex number and can be represented by 4 bits. The collection of 4 bits is called a nibble. During addition or subtraction if a carry goes from one nibble to the next this flag is set. Carry flag is for the carry from the whole addition while auxiliary carry is the carry from the first nibble to the second.
Z	Zero Flag	The Zero flag is set if the last mathematical or logical instruction has produced a zero in its destination.

S	Sign Flag	A signed number is represented in its two's complement form in the computer. The most significant bit (MSB) of a negative number in this representation is 1 and for a positive number it is zero. The sign bit of the last mathematical or logical operation's destination is copied into the sign flag.
T	Trap Flag	The trap flag has a special role in debugging which will be discussed later.
I	Interrupt Flag	It tells whether the processor can be interrupted from outside or not. Sometimes the programmer doesn't want a particular task to be interrupted so the Interrupt flag can be zeroed for this time. The programmer rather than the processor sets this flag since the programmer knows when interruption is okay and when it is not. Interruption can be disabled or enabled by making this bit zero or one, respectively, using special instructions.
D	Direction Flag	Specifically related to string instructions, this flag tells whether the current operation has to be done from bottom to top of the block (D=0) or from top to bottom of the block (D=1).
O	Overflow Flag	The overflow flag is set during signed arithmetic, e.g. addition or subtraction, when the sign of the destination changes unexpectedly. The actual process sets the overflow flag whenever the carry into the MSB is different from the carry out of the MSB

Segment Registers (CS, DS, SS, and ES)

The code segment register, data segment register, stack segment register, and the extra segment register are special registers related to the Intel segmented memory model and will be discussed later.

1.7. OUR FIRST PROGRAM

The first program that we will write will only add three numbers. This very simple program will clarify most of the basic concepts of assembly language. We will start with writing our algorithm in English and then moving on to convert it into assembly language.

English Language Version

"Program is an ordered set of instructions for the processor." Our first program will be instructions manipulating AX and BX in plain English.

```

move 5 to ax
move 10 to bx
add bx to ax
move 15 to bx
add bx to ax

```

Even in this simple reflection of thoughts in English, there are some key things to observe. One is the concept of destination as every instruction has a "to destination" part and there is a source before it as well. For example the second line has a constant 10 as its source and the register BX as its destination. The key point in giving the first program in English is to convey that the concepts of assembly language are simple but fine. Try to understand them considering that all above is everyday English that you know very well and every concept will eventually be applicable to assembly language.

Assembly Language Version

Intel could have made their assembly language exactly identical to our program in plain English but they have abbreviated a lot of symbols to avoid unnecessarily lengthy program when the meaning could be conveyed with less effort. For example Intel has named their move instruction “mov” instead of “move.” Similarly the Intel order of placing source and destination is opposite to what we have used in our English program, just a change of interpretation. So the Intel way of writing things is:

```

operation destination, source
operation destination
operation source
operation

```

The later three variations are for instructions that have one or both of their operands implied or they work on a single or no operand. An implied operand means that it is always in a particular register say the accumulator, and it need not be mentioned in the instruction. Now we attempt to write our program in actual assembly language of the iapx88.

Example 1.1	
001 002 003 004 005 006 007 008 009 010	<pre> ; a program to add three numbers using registers [org 0x0100] mov ax, 5 ; load first number in ax mov bx, 10 ; load second number in bx add ax, bx ; accumulate sum in ax mov bx, 15 ; load third number in bx add ax, bx ; accumulate sum in ax mov ax, 0x4c00 ; terminate program int 0x21 </pre>
001	To start a comment a semicolon is used and the assembler ignores everything else on the same line. Comments must be extensively used in assembly language programs to make them readable.
002	Leave the org directive for now as it will be discussed later.
003	The constant 5 is loaded in one register AX.
004	The constant 10 is loaded in another register BX.
005	Register BX is added to register AX and the result is stored in register AX. Register AX should contain 15 by now.
006	The constant 15 is loaded in the register BX.
007	Register BX is again added to register AX now producing 15+15=30 in the AX register. So the program has computed 5+10+15=30.
008	Vertical spacing must also be used extensively in assembly language programs to separate logical blocks of code.
009-010	The ending lines are related more to the operating system than to assembly language programming. It is a way to inform DOS that our program has terminated so it can display its command prompt again. The computer may reboot or behave improperly if this termination is not present.

Assembler, Linker, and Debugger

We need an assembler to assemble this program and convert this into executable binary code. The assembler that we will use during this course is “Netwide Assembler” or NASM. It is a free and open source assembler. And the tool that will be most used will be the debugger. We will use a free debugger called “A fullscreen debugger” or AFD. These are the whole set of

weapons an assembly language programmer needs for any task whatsoever at hand.

To assemble we will give the following command to the processor assuming that our input file is named EX01.ASM.

```
nasm ex01.asm -o ex01.com -l ex01.lst
```

This will produce two files EX01.COM that is our executable file and EX01.LST that is a special listing file that we will explore now. The listing file produced for our example above is shown below with comments removed for neatness.

```

1
2             [org 0x0100]
3 00000000 B80500      mov ax, 5
4 00000003 BB0A00      mov bx, 10
5 00000006 01D8        add ax, bx
6 00000008 BB0F00      mov bx, 15
7 0000000B 01D8        add ax, bx
8
9 0000000D B8004C      mov ax, 0x4c00
10 00000010 CD21       int 0x21

```

The first column in the above listing is offset of the listed instruction in the output file. Next column is the opcode into which our instruction was translated. In this case this opcode is B8. Whenever we move a constant into AX register the opcode B8 will be used. After it 0500 is appended which is the immediate operand to this instruction. An immediate operand is an operand which is placed directly inside the instruction. Now as the AX register is a word sized register, and one hexadecimal digit takes 4 bits so 4 hexadecimal digits make one word or two bytes. Which of the two bytes should be placed first in the instruction, the least significant or the most significant? Similarly for 32bit numbers either the order can be most significant, less significant, lesser significant, and least significant called the big-endian order used by Motorola and some other companies or it can be least significant, more significant, more significant, and most significant called the little-endian order and is used by Intel. The big-endian have the argument that it is more natural to read and comprehend while the little-endian have the argument that this scheme places the less significant value at a lesser address and more significant value at a higher address.

Because of this the constant 5 in our instruction was converted into 0500 with the least significant byte of 05 first and the most significant byte of 00 afterwards. When read as a word it is 0005 but when written in memory it will become 0500. As the first instruction is three bytes long, the listing file shows that the offset of the next instruction in the file is 3. The opcode BB is for moving a constant into the BX register, and the operand 0A00 is the number 10 in little-endian byte order. Similarly the offsets and opcodes of the remaining instructions are shown in order. The last instruction is placed at offset 0x10 or 16 in decimal. The size of the last instruction is two bytes, so the size of the complete COM file becomes 18 bytes. This can be verified from the directory listing, using the DIR command, that the COM file produced is exactly 18 bytes long.

Now the program is ready to be run inside the debugger. The debugger shows the values of registers, flags, stack, our code, and one or two areas of the system memory as data. Debugger allows us to step our program one instruction at a time and observe its effect on the registers and program data. The details of using the AFD debugger can be seen from the AFD manual.

After loading the program in the debugger observe that the first instruction is now at 0100 instead of absolute zero. This is the effect of the org directive at the start of our program. The first instruction of a COM file must be at

Computer Architecture & Assembly Language Programming	Course Code: CS401
CS401@vu.edu.pk	VU

offset 0100 (decimal 255) as a requirement. Also observe that the debugger is showing your program even though it was provided only the COM file and neither of the listing file or the program source. This is because the translation from mnemonic to opcode is reversible and the debugger mapped back from the opcode to the instruction mnemonic. This will become apparent for instructions that have two mnemonics as the debugger might not show the one that was written in the source file.

As a result of program execution either registers or memory will change. Since our program yet doesn't touch memory the only changes will be in the registers. Keenly observe the registers AX, BX, and IP change after every instruction. IP will change after every instruction to point to the next instruction while AX will accumulate the result of our addition.

1.8. SEGMENTED MEMORY MODEL

Rationale

In earlier processors like 8080 and 8085 the linear memory model was used to access memory. In linear memory model the whole memory appears like a single array of data. 8080 and 8085 could access a total memory of 64K using the 16 lines of their address bus. When designing iAPX88 the Intel designers wanted to remain compatible with 8080 and 8085 however 64K was too small to continue with, for their new processor. To get the best of both worlds they introduced the segmented memory model in 8088.

There is also a logical argument in favor of a segmented memory model in addition to the issue of compatibility discussed above. We have two logical parts of our program, the code and the data, and actually there is a third part called the program stack as well, but higher level languages make this invisible to us. These three logical parts of a program should appear as three distinct units in memory, but making this division is not possible in the linear memory model. The segmented memory model does allow this distinction.

Mechanism

The segmented memory model allows multiple functional windows into the main memory, a code window, a data window etc. The processor sees code from the code window and data from the data window. The size of one window is restricted to 64K. 8085 software fits in just one such window. It sees code, data, and stack from this one window, so downward compatibility is attained.

However the maximum memory iAPX88 can access is 1MB which can be accessed with 20 bits. Compare this with the 64K of 8085 that were accessed using 16 bits. The idea is that the 64K window just discussed can be moved anywhere in the whole 1MB. The four segment registers discussed in the Intel register architecture are used for this purpose. Therefore four windows can exist at one time. For example one window that is pointed to by the CS register contains the currently executing code.

To understand the concept, consider the windows of a building. We say that a particular window is 3 feet above the floor and another one is 20 feet above the floor. The reference point, the floor is the base of the segment called the datum point in a graph and all measurement is done from that datum point considering it to be zero. So CS holds the zero or the base of code. DS holds the zero of data. Or we can say CS tells how high code from the floor is, and DS tells how high data from the floor is, while SS tells how high the stack is. One extra segment ES can be used if we need to access two distant areas of memory at the same time that both cannot be seen through the same window. ES also has special role in string instructions. ES is used as an extra data segment and cannot be used as an extra code or stack segment.

Revisiting the concept again, like the datum point of a graph, the segment registers tell the start of our window which can be opened anywhere in the megabyte of memory available. The window is of a fixed size of 64KB. Base and offset are the two key variables in a segmented address. Segment tells the base while offset is added into it. The registers IP, SP, BP, SI, DI, and BX all can contain a 16bit offset in them and access memory relative to a segment base.

The IP register cannot work alone. It needs the CS register to open a 64K window in the 1MB memory and then IP works to select code from this window as offsets. IP works only inside this window and cannot go outside of this 64K in any case. If the window is moved i.e. the CS register is changed, IP will change its behavior accordingly and start selecting from the new window. The IP register always works relatively, relative to the segment base stored in the CS register. IP is a 16bit register capable of accessing only 64K memory so how the whole megabyte can contain code anywhere. Again the same concept is there, it can access 64K at one instance of time. As the base is changed using the CS register, IP can be made to point anywhere in the whole megabyte. The process is illustrated with the following diagram.

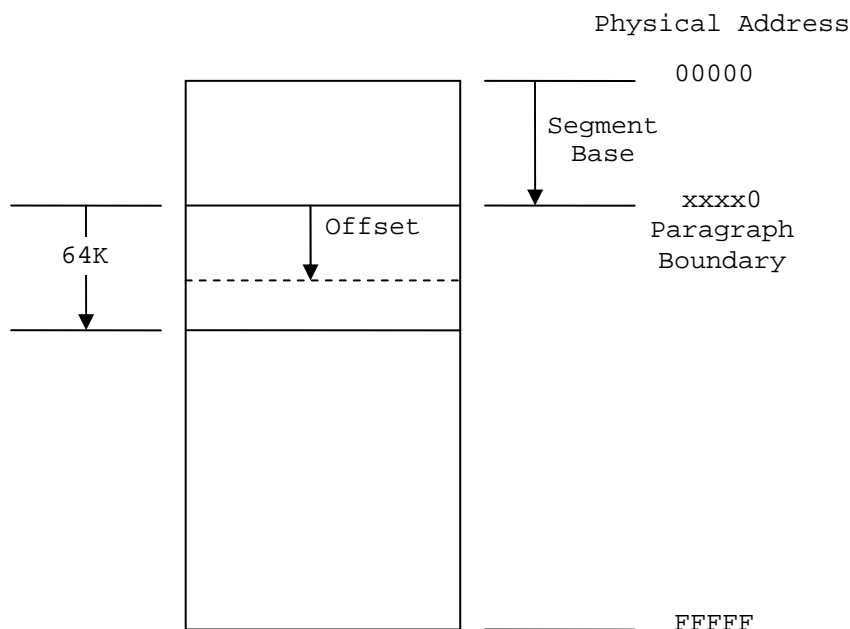

Physical Address Calculation

Now for the whole megabyte we need 20 bits while CS and IP are both 16bit registers. We need a mechanism to make a 20bit number out of the two 16bit numbers. Consider that the segment value is stored as a 20 bit number with the lower four bits zero and the offset value is stored as another 20 bit number with the upper four bits zeroed. The two are added to produce a 20bit absolute address. A carry if generated is dropped without being stored anywhere and the phenomenon is called address wraparound. The process is explained with the help of the following diagram.

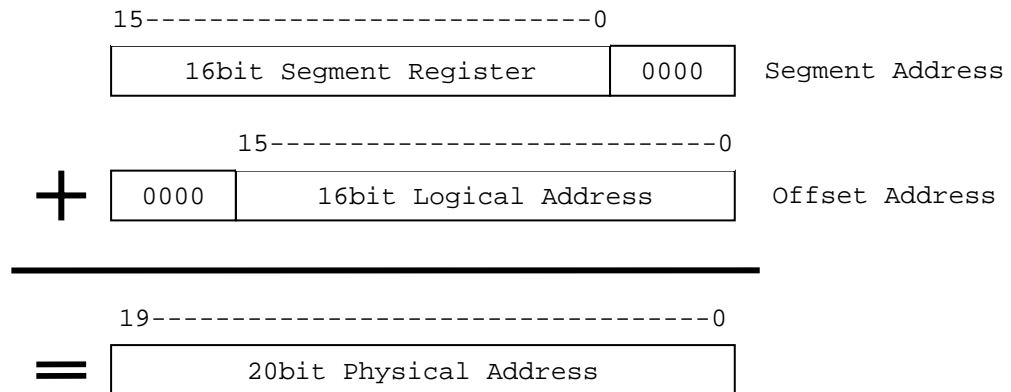

Therefore memory is determined by a segment-offset pair and not alone by any one register which will be an ambiguous reference. Every offset register is assigned a default segment register to resolve such ambiguity. For example the program we wrote when loaded into memory had a value of 0100 in IP register and some value say 1DDD in the CS register. Making both 20 bit numbers, the segment base is 1DDD0 and the offset is 00100 and adding them we get the physical memory address of 1DED0 where the opcode B80500 is placed.

Paragraph Boundaries

As the segment value is a 16bit number and four zero bits are appended to the right to make it a 20bit number, segments can only be defined a 16byte boundaries called paragraph boundaries. The first possible segment value is 0000 meaning a physical base of 00000 and the next possible value of 0001 means a segment base of 00010 or 16 in decimal. Therefore segments can only be defined at 16 byte boundaries.

Overlapping Segments

We can also observe that in the case of our program CS, DS, SS, and ES all had the same value in them. This is called overlapping segments so that we can see the same memory from any window. This is the structure of a COM file.

Using partially overlapping segments we can produce a number of segment, offset pairs that all access the same memory. For example 1DDD:0100 and IDED:0000 both point to the same physical memory. To test this we can open a data window at 1DED:0000 in the debugger and change the first three bytes to "90" which is the opcode for NOP (no operation). The change is immediately visible in the code window which is pointed to by CS containing 1DDD. Similarly IDCD:0200 also points to the same memory location. Consider this like a portion of wall that three different people on three different floors are seeing through their own windows. One of them painted the wall red; it will be changed for all of them though their perspective is different. It is the same phenomenon occurring here.

The segment, offset pair is called a logical address, while the 20bit address is a physical address which is the real thing. Logical addressing is a mechanism to access the physical memory. As we have seen three different logical addresses accessed the same physical address.

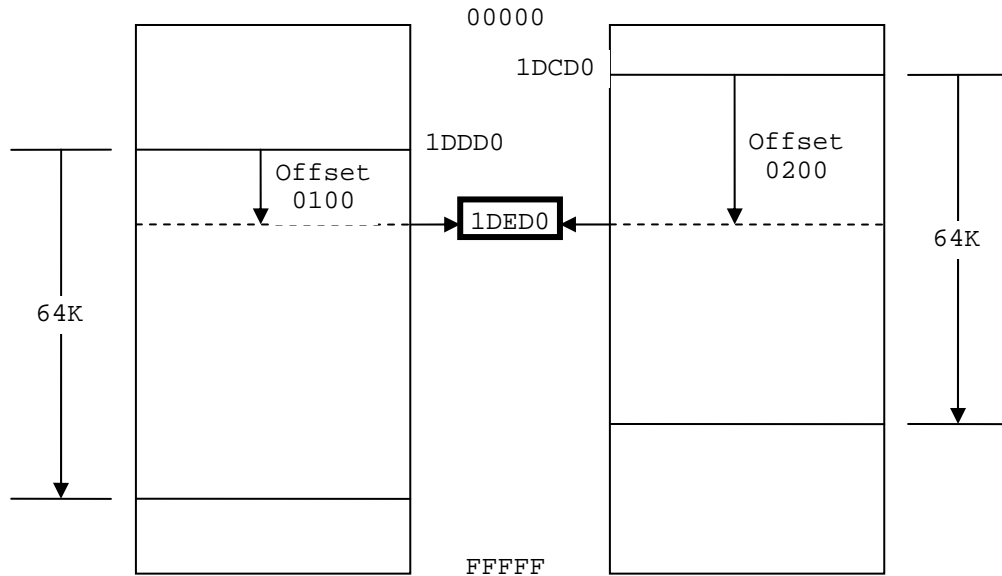

EXERCISES

- How the processor uses the address bus, the data bus, and the control bus to communicate with the system memory?
- Which of the following are unidirectional and which are bidirectional?
 - Address Bus
 - Data Bus
 - Control Bus
- What are registers and what are the specific features of the accumulator, index registers, program counter, and program status word?
- What is the size of the accumulator of a 64bit processor?
- What is the difference between an instruction mnemonic and its opcode?
- How are instructions classified into groups?
- A combination of 8bits is called a byte. What is the name for 4bits and for 16bits?
- What is the maximum memory 8088 can access?
- List down the 14 registers of the 8088 architecture and briefly describe their uses.
- What flags are defined in the 8088 FLAGS register? Describe the function of the zero flag, the carry flag, the sign flag, and the overflow flag.
- Give the value of the zero flag, the carry flag, the sign flag, and the overflow flag after each of the following instructions if AX is initialized with 0x1254 and BX is initialized with 0x0FFF.
 - add ax, 0xEDAB
 - add ax, bx
 - add bx, 0xF001
- What is the difference between little endian and big endian formats? Which format is used by the Intel 8088 microprocessor?
- For each of the following words identify the byte that is stored at lower memory address and the byte that is stored at higher memory address in a little endian computer.
 - 1234
 - ABFC
 - B100
 - B800

Computer Architecture & Assembly Language Programming	Course Code: CS401
CS401@vu.edu.pk	VU

14. What are the contents of memory locations 200, 201, 202, and 203 if the word 1234 is stored at offset 200 and the word 5678 is stored at offset 202?
15. What is the offset at which the first executable instruction of a COM file must be placed?
16. Why was segmentation originally introduced in 8088 architecture?
17. Why a segment start cannot start from the physical address 55555.
18. Calculate the physical memory address generated by the following segment offset pairs.
 - a. 1DDD:0436
 - b. 1234:7920
 - c. 74F0:2123
 - d. 0000:6727
 - e. FFFF:4336
 - f. 1080:0100
 - g. AB01:FFFF
19. What are the first and the last physical memory addresses accessible using the following segment values?
 - a. 1000
 - b. 0FFF
 - c. 1002
 - d. 0001
 - e. E000
20. Write instructions that perform the following operations.
 - a. Copy BL into CL
 - b. Copy DX into AX
 - c. Store 0x12 into AL
 - d. Store 0x1234 into AX
 - e. Store 0xFFFF into AX
21. Write a program in assembly language that calculates the square of six by adding six to the accumulator six times.

Addressing Modes

2.1. DATA DECLARATION

The first instruction of our first assembly language program was “mov ax, 5.” Here MOV was the opcode; AX was the destination operand, while 5 was the source operand. The value of 5 in this case was stored as part of the instruction encoding. In the opcode B80500, B8 was the opcode and 0500 was the operand stored immediately afterwards. Such an operand is called an immediate operand. It is one of the many types of operands available.

Writing programs using just the immediate operand type is difficult. Every reasonable program needs some data in memory apart from constants. Constants cannot be changed, i.e. they cannot appear as the destination operand. In fact placing them as destination is meaningless and illegal according to assembly language syntax. Only registers or data placed in memory can be changed. So real data is the one stored in memory, with a very few constants. So there must be a mechanism in assembly language to store and retrieve data from memory.

To declare a part of our program as holding data instead of instructions we need a couple of very basic but special assembler directives. The first directive is “define byte” written as “db.”

```
db    somevalue
```

As a result a cell in memory will be reserved containing the desired value in it and it can be used in a variety of ways. Now we can add variables instead of constants. The other directive is “define word” or “dw” with the same syntax as “db” but reserving a whole word of 16 bits instead of a byte. There are directives to declare a double or a quad word as well but we will restrict ourselves to byte and word declarations for now. For single byte we use db and for two bytes we use dw.

To refer to this variable later in the program, we need the address occupied by this variable. The assembler is there to help us. We can associate a symbol with any address that we want to remember and use that symbol in the rest of the code. The symbol is there for our own comprehension of code. The assembler will calculate the address of that symbol using our origin directive and calculating the instruction lengths or data declarations in-between and replace all references to the symbol with the corresponding address. This is just like variables in a higher level language, where the compiler translates them into addresses; just the process is hidden from the programmer one level further. Such a symbol associated to a point in the program is called a label and is written as the label name followed by a colon.

2.2. DIRECT ADDRESSING

Now we will rewrite our first program such that the numbers 5, 10, and 15 are stored as memory variables instead of constants and we access them from there.

Example 2.1

001	; a program to add three numbers using memory variables
002	[org 0x0100]
003	mov ax, [num1] ; load first number in ax

004	mov	bx, [num2]	; load second number in bx
005	add	ax, bx	; accumulate sum in ax
006	mov	bx, [num3]	; load third number in bx
007	add	ax, bx	; accumulate sum in ax
008	mov	[num4], ax	; store sum in num4
009			
010	mov	ax, 0x4c00	; terminate program
011	int	0x21	
012			
013	num1:	dw	5
014	num2:	dw	10
015	num3:	dw	15
016	num4:	dw	0

002 Originate our program at 0100. The first executable instruction should be placed at this offset.

003 The source operand is changed from constant 5 to [num1]. The bracket is signaling that the operand is placed in memory at address num1. The value 5 will be loaded in ax even though we did not specified it in our program code, rather the value will be picked from memory. The instruction should be read as “read the contents of memory location num1 in the ax register.” The label num1 is a symbol for us but an address for the processor while the conversion is done by the assembler.

013 The label num1 is defined as a word and the assembler is requested to place 5 in that memory location. The colon signals that num1 is a label and not an instruction.

Using the same process to assemble as discussed before we examine the listing file generated as a result with comments removed.

1			
2		[org 0x0100]	
3	00000000	A1[1700]	mov ax, [num1]
4	00000003	8B1E[1900]	mov bx, [num2]
5	00000007	01D8	add ax, bx
6	00000009	8B1E[1B00]	mov bx, [num3]
7	0000000D	01D8	add ax, bx
8	0000000F	A3[1D00]	mov [num4], ax
9			
10	00000012	B8004C	mov ax, 0x4c00
11	00000015	CD21	int 0x21
12			
13	00000017	0500	num1: dw 5
14	00000019	0A00	num2: dw 10
15	0000001B	0F00	num3: dw 15
16	0000001D	0000	num4: dw 0

The first instruction of our program has changed from B80500 to A11700. The opcode B8 is used to move constants into AX, while the opcode A1 is used when moving data into AX from memory. The immediate operand to our new instruction is 1700 or as a word 0017 (23 decimal) and from the bottom of the listing file we can observe that this is the offset of num1. The assembler has calculated the offset of num1 and used it to replace references to num1 in the whole program. Also the value 0500 can be seen at offset 0017 in the file. We can say contents of memory location 0017 are 0005 as a word. Similarly num2, num3, and num4 are placed at 0019, 001B, and 001D addresses.

When the program is loaded in the debugger, it is loaded at offset 0100, which displaces all memory accesses in our program. The instruction A11700 is changed to A11701 meaning that our variable is now placed at 0117 offset. The instruction is shown as mov ax, [0117]. Also the data window can be used to verify that offset 0117 contains the number 0005.

Execute the program step by step and examine how the memory is read and the registers are updated, how the instruction pointer moves forward, and how the result is saved back in memory. Also observe inside the debugger code window below the code for termination, that the debugger is interpreting our data as code and showing it as some meaningless instructions. This is because the debugger sees everything as code in the code window and cannot differentiate our declared data from opcodes. It is our responsibility that we terminate execution before our data is executed as code.

Also observe that our naming of num1, num2, num3, and num4 is no longer there inside the debugger. The debugger is only showing the numbers 0117, 0119, 011B, and 011D. Our numerical machine can only work with numbers. We used symbols for our ease to label or tag certain positions in our program. The assembler converts these symbols into the appropriate numbers automatically. Also observe that the effect of “dw” is to place 5 in two bytes as 0005. Had we used “db” this would have been stored as 05 in one byte.

Given the fact that the assembler knows only numbers we can write the same program using a single label. As we know that num2 is two ahead of num1, we can use num1+2 instead of num2 and let the assembler calculate the sum during assembly process.

Example 2.2	
001	; a program to add three numbers accessed using a single label
002	[org 0x0100]
003	mov ax, [num1] ; load first number in ax
004	mov bx, [num1+2] ; load second number in bx
005	add ax, bx ; accumulate sum in ax
006	mov bx, [num1+4] ; load third number in bx
007	add ax, bx ; accumulate sum in ax
008	mov [num1+6], ax ; store sum at num1+6
009	
010	mov ax, 0x4c00 ; terminate program
011	int 0x21
012	
013	num1: dw 5
014	dw 10
015	dw 15
016	dw 0
004	The second number is read from num1+2. Similarly the third number is read from num1+4 and the result is accessed at num1+6.
013-016	The labels num2, num3, and num4 are removed and the data there will be accessed with reference to num1.

Every location is accessed with reference to num1 in this example. The expression “num1+2” comprises of constants only and can be evaluated at the time of assembly. There are no variables involved in this expression. As we open the program inside the debugger we see a verbatim copy of the previous program. There is no difference at all since the assembler catered for the differences during assembly. It calculated 0117+2=0119 while in the previous it directly knew from the value of num2 that it has to write 0119, but the end result is a ditto copy of the previous execution.

Another way to declare the above data and produce exactly same results is shown in the following example.

Example 2.3	
001	; a program to add three numbers accessed using a single label
002	[org 0x0100]
003	mov ax, [num1] ; load first number in ax
004	mov bx, [num1+2] ; load second number in bx

```

005          add ax, bx           ; accumulate sum in ax
006          mov bx, [num1+4]     ; load third number in bx
007          add ax, bx           ; accumulate sum in ax
008          mov [num1+6], ax     ; store sum at num1+6
009
010          mov ax, 0x4c00       ; terminate program
011          int 0x21
012
013 num1:     dw 5, 10, 15, 0

```

013 As we do not need to place labels on individual variables we can save space and declare all data on a single line separated by commas. This declaration will declare four words in consecutive memory locations while the address of first one is num1.

The method used to access memory in the above examples is called direct addressing. In direct addressing the memory address is fixed and is given in the instruction. The actual data used is placed in memory and now that data can be used as the destination operand as well. Also the source and destination operands must have the same size. For example a word defined memory is read in a word sized register. A last observation is that the data 0500 in memory was corrected to 0005 when read in a register. So registers contain data in proper order as a word.

A last variation using direct addressing shows that we can directly add a memory variable and a register instead of adding a register into another that we were doing till now.

Example 2.4

```

01          ; a program to add three numbers directly in memory
02          [org 0x0100]
03          mov ax, [num1]        ; load first number in ax
04          mov [num1+6], ax     ; store first number in result
05          mov ax, [num1+2]     ; load second number in ax
06          add [num1+6], ax     ; add second number to result
07          mov ax, [num1+4]     ; load third number in ax
08          add [num1+6], ax     ; add third number to result
09
10          mov ax, 0x4c00       ; terminate program
11          int 0x21
12
13 num1:     dw 5, 10, 15, 0

```

We generate the following listing file as a result of the assembly process described previously. Comments are again removed.

```

1
2          [org 0x0100]
3 00000000 A1[1900]             mov ax, [num1]
4 00000003 A3[1F00]             mov [num1+6], ax
5 00000006 A1[1B00]             mov ax, [num1+2]
6 00000009 0106[1F00]          add [num1+6], ax
7 0000000D A1[1D00]             mov ax, [num1+4]
8 00000010 0106[1F00]          add [num1+6], ax
9
10 00000014 B8004C              mov ax, 0x4c00
11 00000017 CD21                int 0x21
12
13 00000019 0500A000F000000     num1:     dw 5, 10, 15, 0

```

The opcode of add is changed because the destination is now a memory location instead of a register. No other significant change is seen in the listing file. Inside the debugger we observe that few opcodes are longer now and the location num1 is now translating to 0119 instead of 0117. This is done automatically by the assembler as a result of using labels instead of

hard coding addresses. During execution we observe that the word data as it is read into a register is read in correct order. The significant change in this example is that the destination of addition is memory. Method to access memory is direct addressing, whether it is the MOV instruction or the ADD instruction.

The first two instructions of the last program read a number into AX and placed it at another memory location. A quick thought reveals that the following might be a possible single instruction to replace the couple.

```
mov [num1+6], [num1] ; ILLEGAL
```

However this form is illegal and not allowed on the Intel architecture. None of the general operations of mov add, sub etc. allow moving data from memory to memory. Only register to register, register to memory, memory to register, constant to memory, and constant to register operations are allowed. The other register to constant, memory to constant, and memory to memory are all disallowed. Only string instructions allow moving data from memory to memory and will be discussed in detail later. As a rule one instruction can have at most one operand in brackets, otherwise assembler will give an error.

2.3. SIZE MISMATCH ERRORS

If we change the directive in the last example from DW to DB, the program will still assemble and debug without errors, however the results will not be the same as expected. When the first operand is read 0A05 will be read in the register which was actually two operands placed in consecutive byte memory locations. The second number will be read as 000F which is the zero byte of num4 appended to the 15 of num3. The third number will be junk depending on the current state of the machine. According to our data declaration the third number should be at 0114 but it is accessed at 011D calculated with word offsets. This is a logical error of the program. To keep the declarations and their access synchronized is the responsibility of the programmer and not the assembler. The assembler allows the programmer to do everything he wants to do, and that can possibly run on the processor. The assembler only keeps us from writing illegal instructions which the processor cannot execute. This is the difference between a syntax error and a logic error. So the assembler and debugger have both done what we asked them to do but the programmer asked them to do the wrong chore.

The programmer is responsible for accessing the data as word if it was declared as a word and accessing it as a byte if it was declared as a byte. The word case is shown in lot of previous examples. If however the intent is to treat it as a byte the following code shows the appropriate way.

Example 2.5	
001	; a program to add three numbers using byte variables
002	[org 0x0100]
003	mov al, [num1] ; load first number in al
004	mov bl, [num1+1] ; load second number in bl
005	add al, bl ; accumulate sum in al
006	mov bl, [num1+2] ; load third number in bl
007	add al, bl ; accumulate sum in al
008	mov [num1+3], al ; store sum at num1+3
009	
010	mov ax, 0x4c00 ; terminate program
011	int 0x21
012	
013	num1: db 5, 10, 15, 0
003	The number is read in AL register which is a byte register since the memory location read is also of byte size.
005	The second number is now placed at num1+1 instead of num1+2 because of byte offsets.

013 To declare data db is used instead of dw so that each data declared occupies one byte only.

Inside the debugger we observe that the AL register takes appropriate values and the sum is calculated and stored in num1+3. This time there is no alignment or synchronization error. The key thing to understand here is that the processor does not match defines to accesses. It is the programmer's responsibility. In general assembly language gives a lot of power to the programmer but power comes with responsibility. Assembly language programming is not a difficult task but a responsible one.

In the above examples, the processor knew the size of the data movement operation from the size of the register involved, for example in "mov ax, [num1]" memory can be accessed as byte or as word, it has no hard and fast size, but the AX register tells that this operation has to be a word operation. Similarly in "mov al, [num1]" the AL register tells that this operation has to be a byte operation. However in "mov ax, bl" the AX register tells that the operation has to be a word operation while BL tells that this has to be a byte operation. The assembler will declare that this is an illegal instruction. A 5Kg bag cannot fit inside a 1Kg bag and according to Intel a 1Kg cannot also fit in a 5Kg bag. They must match in size. The instruction "mov [num1], [num2]" is illegal as previously discussed not because of data movement size but because memory to memory moves are not allowed at all.

The instruction "mov [num1], 5" is legal but there is no way for the processor to know the data movement size in this operation. The variable num1 can be treated as a byte or as a word and similarly 5 can be treated as a byte or as a word. Such instructions are declared ambiguous by the assembler. The assembler has no way to guess the intent of the programmer as it previously did using the size of the register involved but there is no register involved this time. And memory is a linear array and label is an address in it. There is no size associated with a label. Therefore to resolve its ambiguity we clearly tell our intent to the assembler in one of the following ways.

```
mov byte [num1], 5
mov word [num1], 5
```

2.4. REGISTER INDIRECT ADDRESSING

We have done very elementary data access till now. Assume that the numbers we had were 100 and not just three. This way of adding them will cost us 200 instructions. There must be some method to do a task repeatedly on data placed in consecutive memory cells. The key to this is the need for some register that can hold the address of data. So that we can change the address to access some other cell of memory using the same instruction. In direct addressing mode the memory cell accessed was fixed inside the instruction. There is another method in which the address can be placed in a register so that it can be changed. For the following example we will take 10 instead of 100 numbers but the algorithm is extensible to any size.

There are four registers in iAPX88 architecture that can hold address of data and they are BX, BP, SI, and DI. There are minute differences in their working which will be discussed later. For the current example, we will use the BX register and we will take just three numbers and extend the concept with more numbers in later examples.

Example 2.6	
001	; a program to add three numbers using indirect addressing
002	[org 0x100]
003	mov bx, num1 ; point bx to first number
004	mov ax, [bx] ; load first number in ax
005	add bx, 2 ; advance bx to second number

006	add ax, [bx]	; add second number to ax
007	add bx, 2	; advance bx to third number
008	add ax, [bx]	; add third number to ax
009	add bx, 2	; advance bx to result
010	mov [bx], ax	; store sum at num1+6
011		
012	mov ax, 0x4c00	; terminate program
013	int 0x21	
014		
015	num1: dw 5, 10, 15, 0	
003	Observe that no square brackets around num1 are used this time. The address is loaded in bx and not the contents. Value of num1 is 0005 and the address is 0117. So BX will now contain 0117.	
004	Brackets are now used around BX. In iapx88 architecture brackets can be used around BX, BP, SI, and DI only. In iapx386 more registers are allowed. The instruction will be read as “move into ax the contents of the memory location whose address is in bx.” Now since bx contains the address of num1 the contents of num1 are transferred to the ax register. Without square brackets the meaning of the instruction would have been totally different.	
005	This instruction is changing the address. Since we have words not bytes, we add two to bx so that it points to the next word in memory. BX now contains 0119 the address of the second word in memory. This was the mechanism to change addresses that we needed.	

Inside the debugger we observe that the first instruction is “mov bx, 011C.” A constant is moved into BX. This is because we did not use the square brackets around “num1.” The address of “num1” has moved to 011C because the code size has changed due to changed instructions. In the second instruction BX points to 011C and the value read in AX is 0005 which can be verified from the data window. After the addition BX points to 011E containing 000A, our next word, and so on. This way the BX register points to our words one after another and we can add them using the same instruction “mov ax, [bx]” without fixing the address of our data in the instructions. We can also subtract from BX to point to previous cells. The address to be accessed is now in total program control.

One thing that we needed in our problem to add hundred numbers was the capability to change address. The second thing we need is a way to repeat the same instruction and a way to know that the repetition is done a 100 times, a terminal condition for the repetition. For the task we are introducing two new instructions that you should read and understand as simple English language concepts. For simplicity only 10 numbers are added in this example. The algorithm is extensible to any size.

Example 2.7		
001	; a program to add ten numbers	
002	[org 0x0100]	
003	mov bx, num1	; point bx to first number
004	mov cx, 10	; load count of numbers in cx
005	mov ax, 0	; initialize sum to zero
006		
007	l1: add ax, [bx]	; add number to ax
008	add bx, 2	; advance bx to next number
009	sub cx, 1	; numbers to be added reduced
010	jnz l1	; if numbers remain add next
011		
012	mov [total], ax	; write back sum in memory
013		
014	mov ax, 0x4c00	; terminate program
015	int 0x21	
016		
017	num1: dw 10, 20, 30, 40, 50, 10, 20, 30, 40, 50	

018	total: dw 0
006	Labels can be used on code as well. Just like data labels they remember the address at which they are used. The assembler does not differentiate between code labels and data labels. The programmer is responsible for using a data label as data and a code label as code. The label l1 in this case is the address of the following instruction.
009	SUB is the counterpart to ADD with the same rules as that of the ADD instruction.
010	JNZ stands for “jump if not zero.” NZ is the condition in this instruction. So the instruction is read as “jump to the location l1 if the zero flag is not set.” And revisiting the zero flag definition “the zero flag is set if the last mathematical or logical operation has produced a zero in its destination.” For example “mov ax, 0” will not set the zero flag as it is not a mathematical or logical instruction. However subtraction and addition will set it. Also it is set even when the destination is not a register. Now consider the subtraction immediately preceding it. If the CX register becomes zero as a result of this subtraction the zero flag will be set and the jump will be taken. And jump to l1, the processor needs to be told each and everything and the destination is an important part of every jump. Just like when we ask someone to go, we mention go to this market or that house. The processor is much more logical than us and needs the destination in every instruction that asks it to go somewhere. The processor will load l1 in the IP register and resume execution from there. The processor will blindly go to the label we mention even if it contains data and not code.

The CX register is used as a counter in this example, BX contains the changing address, while AX accumulates the result. We have formed a loop in assembly language that executes until its condition remains true. Inside the debugger we can observe that the subtract instruction clears the zero flag the first nine times and sets it on the tenth time. While the jump instruction moves execution to address l1 the first nine times and to the following line the tenth time. The jump instruction breaks program flow.

The JNZ instruction is from the program control group and is a conditional jump, meaning that if the condition NZ is true (ZF=0) it will jump to the address mentioned and otherwise it will progress to the next instruction. It is a selection between two paths. If the condition is true go right and otherwise go left. Or we can say if the weather is hot, go this way, and if it is cold, go this way. Conditional jump is the most important instruction, as it gives the processor decision making capability, so it must be given a careful thought. Some processors call it branch, probably a more logical name for it, however the functionality is same. Intel chose to name it “jump.”

An important thing in the above example is that a register is used to reference memory so this form of access is called register indirect memory access. We used the BX register for it and the B in BX and BP stands for base therefore we call register indirect memory access using BX or BP, “based addressing.” Similarly when SI or DI is used we name the method “indexed addressing.” They have the same functionality, with minor differences because of which the two are called base and index. The differences will be explained later, however for the above example SI or DI could be used as well, but we would name it indexed addressing instead of based addressing.

2.5. REGISTER + OFFSET ADDRESSING

Direct addressing and indirect addressing using a single register are two basic forms of memory access. Another possibility is to use different combinations of direct and indirect references. In the above example we used BX to access different array elements which were placed consecutively in memory like an array. We can also place in BX only the array index and not the exact address and form the exact address when we are going to access the actual memory. This way the same register can be used for accessing different arrays and also the register can be used for index comparison like the following example does.

Example 2.8	
001	; a program to add ten numbers using register + offset addressing
002	[org 0x0100]
003	mov bx, 0 ; initialize array index to zero
004	mov cx, 10 ; load count of numbers in cx
005	mov ax, 0 ; initialize sum to zero
006	
007	l1: add ax, [num1+bx] ; add number to ax
008	add bx, 2 ; advance bx to next index
009	sub cx, 1 ; numbers to be added reduced
010	jnz l1 ; if numbers remain add next
011	
012	mov [total], ax ; write back sum in memory
013	
014	mov ax, 0x4c00 ; terminate program
015	int 0x21
016	
017	num1: dw 10, 20, 30, 40, 50, 10, 20, 30, 40, 50
018	total: dw 0
003	This time BX is initialized to zero instead of array base
007	The format of memory access has changed. The array base is added to BX containing array index at the time of memory access.
008	As the array is of words, BX jumps in steps of two, i.e. 0, 2, 4. Higher level languages do appropriate incrementing themselves and we always use sequential array indexes. However in assembly language we always calculate in bytes and therefore we need to take care of the size of one array element which in this case is two.

Inside the debugger we observe that the memory access instruction is shown as “mov ax, [011F+bx]” and the actual memory accessed is the one whose address is the sum of 011F and the value contained in the BX register. This form of access is of the register indirect family and is called base + offset or index + offset depending on whether BX or BP is used or SI or DI is used.

2.6. SEGMENT ASSOCIATION

All the addressing mechanisms in iAPX88 return a number called *effective address*. For example in base + offset addressing, neither the base nor the offset alone tells the desired cell in memory to be accessed. It is only after the addition is done that the processor knows which cell to be accessed. This number which came as the result of addition is called the effective address. But the effective address is just an offset and is meaningless without a segment. Only after the segment is known, we can form the physical address that is needed to access a memory cell.

We discussed the segmented memory model of iAPX88 in reasonable detail at the end of previous chapter. However during the discussion of addressing modes we have not seen the effect of segments. Segmentation is there and it's all happening relative to a segment base. We saw DS, CS, SS, and ES

Computer Architecture & Assembly Language Programming	Course Code: CS401
CS401@vu.edu.pk	VU

inside the debugger. Everything is relative to its segment base, even though we have not explicitly explained its functionality. An offset alone is not complete without a segment. As previously discussed there is a default segment associated to every register which accesses memory. For example CS is associated to IP by default; rather it is tied with it. It cannot access memory in any other segment.

In case of data, there is a bit relaxation and nothing is tied. Rather there is a default association which can be overridden. In the case of register indirect memory access, if the register used is one of SI, DI, or BX the default segment is DS. If however the register used is BP the default segment used is SS. The stack segment has a very critical and fine use and there is a reason why BP is attached to SS by default. However these will be discussed in detail in the chapter on stack. IP is tied to CS while SP is tied to SS. The association of these registers cannot be changed; they are locked with no option. Others are not locked and can be changed.

To override the association for one instruction of one of the registers BX, BP, SI or DI, we use the segment override prefix. For example “mov ax, [cs:bx]” associates BX with CS for this one instruction. For the next instruction the default association will come back to act. The processor places a special byte before the instruction called a prefix, just like prefixes and suffixes in English language. No prefix is needed or placed for default association. For example for CS the byte 2E is placed and for ES the byte 26 is placed. Opcode has not changed, but the prefix byte has modified the default association to association with the desired segment register for this one instruction.

In all our examples, we never declared a segment or used it explicitly, but everything seemed to work fine. The important thing to note is that CS, DS, SS, and ES all had the same value. The value itself is not important but the fact that all had the same value is important. All four segment windows exactly overlap. Whatever segment register we use the same physical memory will be accessed. That is why everything was working without the mention of a single segment register. This is the formation of COM files in IBM PC. A single segment contains code, data, and the stack. This format is operating system dependant, in our case defined by DOS. And our operating system defines the format of COM files such that all segments have the same value. Thus the only meaningful thing that remains is the offset.

For example if BX=0100, SI=0200, and CS=1000 and the memory access under consideration is [cs:bx+si+0x0700], the effective address formed is $bx+si+0700 = 0100 + 0200 + 0700 = 0A00$. Now multiplying the segment value by 16 makes it 10000 and adding the effective address 00A00 forms the physical address 10A00.

2.7. ADDRESS WRAPAROUND

There are two types of wraparounds. One is within a single segment and the other is inside the whole physical memory. Segment wraparound occurs when during the effective address calculation a carry is generated. This carry is dropped giving the effect that when we try to access beyond the segment limit, we are actually wrapped around to the first cell in the segment. For example if BX=9100, DS=1500 and the access is [bx+0x7000] we form the effective address $9100 + 7000 = 10100$. The carry generated is dropped forming the actual effective address of 0100. Just like a circle when we reached the end we started again from the beginning. An arc at 370 degrees is the same as an arc at 10 degrees. We tried to cross the segment boundary and it pushed us back to the start. This is called segment wraparound. The physical address in the above example will be 15100.

The same can also happen at the time of physical address calculation. For example BX=0100, DS=FFF0 and the access under consideration is [bx+0x0100]. The effective address will be 0200 and the physical address will

Computer Architecture & Assembly Language Programming	Course Code: CS401
CS401@vu.edu.pk	VU

be 100100. This is a 21bit answer and cannot be sent on the address bus which is 20 bits wide. The carry is dropped and just like the segment wraparound our physical memory has wrapped around at its very top. When we tried to access beyond limits the actual access is made at the very start. This second wraparound is a bit different in newer processor with more address lines but that will be explained in later chapters.

2.8. ADDRESSING MODES SUMMARY

The iAPX88 processor supports seven modes of memory access. Remember that immediate is not an addressing mode but an operand type. Operands can be immediate, register, or memory. If the operand is memory one of the seven addressing modes will be used to access it. The memory access mechanisms can also be written in the general form “base + index + offset” and we can define the possible addressing modes by saying that any one, two, or none can be skipped from the general form to form a legal memory access.

There are a few common mistakes done in forming a valid memory access. Part of a register cannot be used to access memory. Like BX is allowed to hold an address but BL or BH are not. Address is 16bit and must be contained in a 16bit register. BX-SI is not possible. The only thing that we can do is addition of a base register with an index register. Any other operation is disallowed. BS+BP and SI+DI are both disallowed as we cannot have two base or two index registers in one memory access. One has to be a base register and the other has to be an index register and that is the reason of naming them differently.

Direct

A fixed offset is given in brackets and the memory at that offset is accessed. For example “mov [1234], ax” stores the contents of the AX registers in two bytes starting at address 1234 in the current data segment. The instruction “mov [1234], al” stores the contents of the AL register in the byte at offset 1234.

Based Register Indirect

A base register is used in brackets and the actual address accessed depends on the value contained in that register. For example “mov [bx], ax” moves the two byte contents of the AX register to the address contained in the BX register in the current data segment. The instruction “mov [bp], al” moves the one byte content of the AL register to the address contained in the BP register in the current stack segment.

Indexed Register Indirect

An index register is used in brackets and the actual address accessed depends on the value contained in that register. For example “mov [si], ax” moves the contents of the AX register to the word starting at address contained in SI in the current data segment. The instruction “mov [di], ax” moves the word contained in AX to the offset stored in DI in the current data segment.

Based Register Indirect + Offset

A base register is used with a constant offset in this addressing mode. The value contained in the base register is added with the constant offset to get the effective address. For example “mov [bx+300], ax” stores the word contained in AX at the offset attained by adding 300 to BX in the current data segment. The instruction “mov [bp+300], ax” stores the word in AX to the offset attained by adding 300 to BP in the current stack segment.

Computer Architecture & Assembly Language Programming	Course Code: CS401
CS401@vu.edu.pk	VU

Indexed Register Indirect + Offset

An index register is used with a constant offset in this addressing mode. The value contained in the index register is added with the constant offset to get the effective address. For example “mov [si+300], ax” moves the word contained in AX to the offset attained by adding 300 to SI in the current data segment and the instruction “mov [di+300], al” moves the byte contained in AL to the offset attained by adding 300 to DI in the current data segment.

Base + Index

One base and one index register is used in this addressing mode. The value of the base register and the index register are added together to get the effective address. For example “mov [bx+si], ax” moves the word contained in the AX register to offset attained by adding BX and SI in the current data segment. The instruction “mov [bp+di], al” moves the byte contained in AL to the offset attained by adding BP and DI in the current stack segment. Observe that the default segment is based on the base register and not on the index register. This is why base registers and index registers are named separately. Other examples are “mov [bx+di], ax” and “mov [bp+si], ax.” This method can be used to access a two dimensional array such that one dimension is in a base register and the other is in an index register.

Base + Index + Offset

This is the most complex addressing method and is relatively infrequently used. A base register, an index register, and a constant offset are all used in this addressing mode. The values of the base register, the index register, and the constant offset are all added together to get the effective address. For example “mov [bx+si+300], ax” moves the word contents of the AX register to the word in memory starting at offset attained by adding BX, SI, and 300 in the current data segment. Default segment association is again based on the base register. It might be used with the array base of a two dimensional array as the constant offset, one dimension in the base register and the other in the index register. This way all calculation of location of the desired element has been delegated to the processor.

EXERCISES

1. What is a label and how does the assembler differentiate between code labels and data labels?
2. List the seven addressing modes available in the 8088 architecture.
3. Differentiate between effective address and physical address.
4. What is the effective address generated by the following instructions? Every instruction is independent of others. Initially BX=0x0100, num1=0x1001, [num1]=0x0000, and SI=0x0100
 - a. mov ax, [bx+12]
 - b. mov ax, [bx+num1]
 - c. mov ax, [num1+bx]
 - d. mov ax, [bx+si]
5. What is the effective address generated by the following combinations if they are valid. If not give reason. Initially BX=0x0100, SI=0x0010, DI=0x0001, BP=0x0200, and SP=0xFFFF
 - a. bx-si
 - b. bx-bp
 - c. bx+10
 - d. bx-10
 - e. bx+sp
 - f. bx+di
6. Identify the problems in the following instructions and correct them by replacing them with one or two instruction having the same effect.

Computer Architecture & Assembly Language Programming	Course Code: CS401
CS401@vu.edu.pk	VU

- a. `mov [02], [22]`
 - b. `mov [wordvar], 20`
 - c. `mov bx, al`
 - d. `mov ax, [si+di+100]`
7. What is the function of segment override prefix and what changes it brings to the opcode?
 8. What are the two types of address wraparound? What physical address is accessed with `[BX+SI]` if `FFFF` is loaded in `BX`, `SI`, and `DS`.
 9. Write instructions to do the following.
 - a. Copy contents of memory location with offset `0025` in the current data segment into `AX`.
 - b. Copy `AX` into memory location with offset `0FFF` in the current data segment.
 - c. Move contents of memory location with offset `0010` to memory location with offset `002F` in the current data segment.
 10. Write a program to calculate the square of 20 by using a loop that adds 20 to the accumulator 20 times.

3

Branching

3.1. COMPARISON AND CONDITIONS

Conditional jump was introduced in the last chapter to loop for the addition of a fixed number of array elements. The jump was based on the zero flag. There are many other conditions possible in a program. For example an operand can be greater than another operand or it can be smaller. We use comparisons and boolean expressions extensively in higher level languages. They must be available in some form in assembly language, otherwise they could not possibly be made available in a higher level language. In fact they are available in a very fine and purified form.

The basic root instruction for all comparisons is `CMP` standing for compare. The operation of `CMP` is to subtract the source operand from the destination operand, updating the flags without changing either the source or the destination. `CMP` is one of the key instructions as it introduces the capability of conditional routing in the processor.

A closer thought reveals that with subtraction we can check many different conditions. For example if a larger number is subtracted from a smaller number then borrow is needed. The carry flag plays the role of borrow during the subtraction operation. And in this condition the carry flag will be set. If two equal numbers are subtracted the answer is zero and the zero flag will be set. Every significant relation between the destination and source is evident from the sign flag, carry flag, zero flag, and the overflow flag. `CMP` is meaningless without a conditional jump immediately following it.

Another important distinction at this point is the difference between signed and unsigned numbers. In unsigned numbers only the magnitude of the number is important, whereas in signed numbers both the magnitude and the sign are important. For example `-2` is greater than `-3` but `2` is smaller than `3`. The sign has affected our comparisons.

Inside the computer signed numbers are represented in two's complement notation. In essence a number in this representation is still a number, just that now our interpretation of this number will be signed. Whether we use jump above and below or we use jump greater or less will convey our intention to the processor. The jump above and greater operations at first sight seem to be doing the same operation, and similarly below and less operations seem to be similar. However for signed numbers `JG` and `JL` will work properly and for unsigned `JA` and `JB` will work properly and not the other way around.

It is important to note that at the time of comparison, the intent of the programmer to treat the numbers as signed or unsigned is not clear. The subtraction in `CMP` is a normal subtraction. It is only after the comparison, during the conditional jump operation, that the intent is conveyed. At that time with a specific combination of flags checked the intent is satisfied.

For example a number `2` is represented in a word as `0002` while the number `-2` is represented as `FFFE`. In a byte they would be represented as `02` and `FE`. Now both have the same magnitude however the different sign has caused very different representation in two's complement form. Now if the intent is to use `FFFE` or decimal `65534` then the same data would be placed in the word as in case of `-2`. In fact if `-2` and `65534` are compared the processor will set the zero flag signaling that they are exactly equal. As regards an unsigned comparison the number `65534` is much greater than `2`.

So if a JA is taken after comparing -2 in the destination with 2 in the source the jump will be taken. If however JG is used after the same comparison the jump will not be taken as it will consider the sign and with the sign -2 is smaller than 2. The key idea is that -2 and 65534 were both stored in memory in the same form. It was the interpretation that treated it as a signed or as an unsigned number.

The unsigned comparisons see the numbers as 0 being the smallest and 65535 being the largest with the order that $0 < 1 < 2 \dots < 65535$. The signed comparisons see the number -32768 which has the same memory representation as 32768 as the smallest number and 32767 as the largest with the order $-32768 < -32767 < \dots < -1 < 0 < 1 < 2 < \dots < 32767$. All the negative numbers have the same representation as an unsigned number in the range 32768 ... 65535 however the signed interpretation of the signed comparisons makes them be treated as negative numbers smaller than zero.

All meaningful situations both for signed and unsigned numbers than occur after a comparison are detailed in the following table.

DEST = SRC	ZF = 1	When the source is subtracted from the destination and both are equal the result is zero and therefore the zero flag is set. This works for both signed and unsigned numbers.
UDEST < USRC	CF = 1	When an unsigned source is subtracted from an unsigned destination and the destination is smaller, borrow is needed which sets the carry flag.
UDEST ≤ USRC	ZF = 1 OR CF = 1	If the zero flag is set, it means that the source and destination are equal and if the carry flag is set it means a borrow was needed in the subtraction and therefore the destination is smaller.
UDEST ≥ USRC	CF = 0	When an unsigned source is subtracted from an unsigned destination no borrow will be needed either when the operands are equal or when the destination is greater than the source.
UDEST > USRC	ZF = 0 AND CF = 0	The unsigned source and destination are not equal if the zero flag is not set and the destination is not smaller since no borrow was taken. Therefore the destination is greater than the source.
SDEST < SSRC	SF ≠ OF	When a signed source is subtracted from a signed destination and the answer is negative with no overflow than the destination is smaller than the source. If however there is an overflow meaning that the sign has changed unexpectedly, the meanings are reversed and a

		positive number signals that the destination is smaller.
$SDEST \leq SSRC$	$ZF = 1$ OR $SF \neq OF$	If the zero flag is set, it means that the source and destination are equal and if the sign and overflow flags differ it means that the destination is smaller as described above.
$SDEST \geq SSRC$	$SF = OF$	When a signed source is subtracted from a signed destination and the answer is positive with no overflow than the destination is greater than the source. When an overflow is there signaling that sign has changed unexpectedly, we interpret a negative answer as the signal that the destination is greater.
$SDEST > SSRC$	$ZF = 0$ AND $SF = OF$	If the zero flag is not set, it means that the signed operands are not equal and if the sign and overflow match in addition to this it means that the destination is greater than the source.

3.2. CONDITIONAL JUMPS

For every interesting or meaningful situation of flags, a conditional jump is there. For example JZ and JNZ check the zero flag. If in a comparison both operands are same, the result of subtraction will be zero and the zero flag will be set. Thus JZ and JNZ can be used to test equality. That is why there are renamed versions JE and JNE read as jump if equal or jump if not equal. They seem more logical in writing but mean exactly the same thing with the same opcode. Many jumps are renamed with two or three names for the same jump, so that the appropriate logic can be conveyed in assembly language programs. This renaming is done by Intel and is a standard for iAPX88. JC and JNC test the carry flag. For example we may need to test whether there was an overflow in the last unsigned addition or subtraction. Carry flag will also be set if two unsigned numbers are subtracted and the first is smaller than the second. Therefore the renamed versions JB, JNAE, and JNB, JAE are there standing for jump if below, jump if not above or equal, jump if not below, and jump if above or equal respectively. The operation of all jumps can be seen from the following table.

JC JB JNAE	Jump if carry Jump if below Jump if not above or equal	CF = 1	This jump is taken if the last arithmetic operation generated a carry or required a borrow. After a CMP it is taken if the unsigned source is smaller than the unsigned destination.
JNC JNB JAE	Jump if not carry Jump if not below Jump if above or equal	CF = 0	This jump is taken if the last arithmetic operation did not

			generated a carry or required a borrow. After a CMP it is taken if the unsigned source is larger or equal to the unsigned destination.
JE JZ	Jump if equal Jump if zero	ZF = 1	This jump is taken if the last arithmetic operation produced a zero in its destination. After a CMP it is taken if both operands were equal.
JNE JNZ	Jump if not equal Jump if not zero	ZF = 0	This jump is taken if the last arithmetic operation did not produce a zero in its destination. After a CMP it is taken if both operands were different.
JA JNBE	Jump if above Jump if not below or equal	ZF = 0 AND CF = 0	This jump is taken after a CMP if the unsigned source is larger than the unsigned destination.
JNA JBE	Jump if not above Jump if not below or equal	ZF = 1 OR CF = 1	This jump is taken after a CMP if the unsigned source is smaller than or equal to the unsigned destination.
JL JNGE	Jump if less Jump if not greater or equal	SF ≠ OF	This jump is taken after a CMP if the signed source is smaller than the signed destination.
JNL JGE	Jump if not less Jump if greater or equal	SF = OF	This jump is taken after a CMP if the signed source is larger than or equal to the signed destination.
JG JNLE	Jump if greater Jump if not less or equal	ZF = 0 AND SF = OF	This jump is taken after a CMP if the signed source is larger than the signed destination.
JNG JLE	Jump if not greater Jump if less or equal	ZF = 1 OR SF ≠ OF	This jump is taken after a CMP if the signed source is smaller than or equal to the signed destination.

JO	Jump if overflow.	OF = 1	This jump is taken if the last arithmetic operation changed the sign unexpectedly.
JNO	Jump if not overflow	OF = 0	This jump is taken if the last arithmetic operation did not change the sign unexpectedly.
JS	Jump if sign	SF = 1	This jump is taken if the last arithmetic operation produced a negative number in its destination.
JNS	Jump if not sign	SF = 0	This jump is taken if the last arithmetic operation produced a positive number in its destination.
JP JPE	Jump if parity Jump if even parity	PF = 1	This jump is taken if the last arithmetic operation produced a number in its destination that has even parity.
JNP JPO	Jump if not parity Jump if odd parity	PF = 0	This jump is taken if the last arithmetic operation produced a number in its destination that has odd parity.
JCXZ	Jump if CX is zero	CX = 0	This jump is taken if the CX register is zero.

The CMP instruction sets the flags reflecting the relation of the destination to the source. This is important as when we say jump if above, then what is above what. The destination is above the source or the source is above the destination.

The JA and JB instructions are related to unsigned numbers. That is our interpretation for the destination and source operands is unsigned. The 16th bit holds data and not the sign. In the JL and JG instructions standing for jump if lower and jump if greater respectively, the interpretation is signed. The 16th bit holds the sign and not the data. The difference between them will be made clear as an elaborate example will be given to explain the difference.

One jump is special that it is not dependant on any flag. It is JCXZ, jump if the CX register is zero. This is because of the special treatment of the CX register as a counter. This jump is regardless of the zero flag. There is no counterpart or not form of this instruction.

The adding numbers example of the last chapter can be a little simplified using the compare instruction on the BX register and eliminating the need for a separate counter as below.

Example 3.1	
001	; a program to add ten numbers without a separate counter
002	[org 0x0100]
003	mov bx, 0 ; initialize array index to zero
004	mov ax, 0 ; initialize sum to zero
005	
006	l1: add ax, [num1+bx] ; add number to ax
007	add bx, 2 ; advance bx to next index
008	cmp bx, 20 ; are we beyond the last index
009	jne l1 ; if not add next number
010	
011	mov [total], ax ; write back sum in memory
012	
013	mov ax, 0x4c00 ; terminate program
014	int 0x21
015	
016	num1: dw 10, 20, 30, 40, 50, 10, 20, 30, 40, 50
017	total: dw 0
006	The format of memory access is still base + offset.
008	BX is used as the array index as well as the counter. The offset of 11th number will be 20, so as soon as BX becomes 20 just after the 10th number has been added, the addition is stopped.
009	The jump is displayed as JNZ in the debugger even though we have written JNE in our example. This is because it is a renamed jump with the same opcode as JNZ and the debugger has no way of knowing the mnemonic that we used after looking just at the opcode. Also every code and data reference that we used till now is seen in the opcode as well. However for the jump instruction we see an operand of F2 in the opcode and not 0116. This will be discussed in detail with unconditional jumps. It is actually a short relative jump and the operand is stored in the form of positive or negative offset from this instruction.

With conditional branching in hand, there are just a few small things left in assembly language that fills some gaps. Now there is just imagination and the skill to conceive programs that can make you write any program.

3.3. UNCONDITIONAL JUMP

Till now we have been placing data at the end of code. There is no such restriction and we can define data anywhere in the code. Taking the previous example, if we place data at the start of code instead of at the end and we load our program in the debugger. We can see our data placed at the start but the debugger is intending to start execution at our data. The COM file definition said that the first executable instruction is at offset 0100 but we have placed data there instead of code. So the debugger will try to interpret that data as code and showed whatever it could make up out of those opcodes.

We introduce a new instruction called JMP. It is the unconditional jump that executes regardless of the state of all flags. So we write an unconditional jump as the very first instruction of our program and jump to the next instruction that follows our data declarations. This time 0100 contains a valid first instruction of our program.

Example 3.2	
001	; a program to add ten numbers without a separate counter
002	[org 0x0100]
003	jmp start ; unconditionally jump over data
004	
005	num1: dw 10, 20, 30, 40, 50, 10, 20, 30, 40, 50
006	total: dw 0

007			
008	start:	mov bx, 0	; initialize array index to zero
009		mov ax, 0	; initialize sum to zero
010			
011	l1:	add ax, [num1+bx]	; add number to ax
012		add bx, 2	; advance bx to next index
013		cmp bx, 20	; are we beyond the last index
014		jne l1	; if not add next number
015			
016		mov [total], ax	; write back sum in memory
017			
018		mov ax, 0x4c00	; terminate program
019		int 0x21	
003	JMP jumps over the data declarations to the start label and execution resumes from there.		

3.4. RELATIVE ADDRESSING

Inside the debugger the instruction is shown as JMP 0119 and the location 0119 contains the original first instruction of the logic of our program. This jump is unconditional, it will always be taken. Now looking at the opcode we see F21600 where F2 is the opcode and 1600 is the operand to it. 1600 is 0016 in proper word order. 0119 is not given as a parameter rather 0016 is given.

This is position relative addressing in contrast to absolute addressing. It is not telling the exact address rather it is telling how much forward or backward to go from the current position of IP in the current code segment. So the instruction means to add 0016 to the IP register. At the time of execution of the first instruction at 0100 IP was pointing to the next instruction at 0103, so after adding 16 it became 0119, the desired target location. The mechanism is important to know, however all calculations in this mechanism are done by the assembler and by the processor. We just use a label with the JMP instruction and are ensured that the instruction at the target label will be the one to be executed.

3.5. TYPES OF JUMP

The three types of jump, near, short, and far, differ in the size of instruction and the range of memory they can jump to with the smallest short form of two bytes and a range of just 256 bytes to the far form of five bytes and a range covering the whole memory.

Short Jump



Near Jump

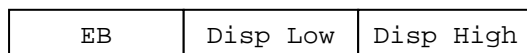

Far Jump

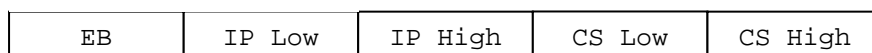

Near Jump

When the relative address stored with the instruction is in 16 bits as in the last example the jump is called a near jump. Using a near jump we can jump anywhere within a segment. If we add a large number it will wrap around to

Computer Architecture & Assembly Language Programming	Course Code: CS401
CS401@vu.edu.pk	VU

the lower part. A negative number actually is a large number and works this way using the wraparound behavior.

Short Jump

If the offset is stored in a single byte as in 75F2 with the opcode 75 and operand F2, the jump is called a short jump. F2 is added to IP as a signed byte. If the byte is negative the complement is negated from IP otherwise the byte is added. Unconditional jumps can be short, near, and far. The far type is yet to be discussed. Conditional jumps can only be short. A short jump can go +127 bytes ahead in code and -128 bytes backwards and no more. This is the limitation of a byte in signed representation.

Far Jump

Far jump is not position relative but is absolute. Both segment and offset must be given to a far jump. The previous two jumps were used to jump within a segment. Sometimes we may need to go from one code segment to another, and near and short jumps cannot take us there. Far jump must be used and a two byte segment and a two byte offset are given to it. It loads CS with the segment part and IP with the offset part. Execution therefore resumes from that location in physical memory. The three instructions that have a far form are JMP, CALL, and RET, are related to program control. Far capability makes intra segment control possible.

3.6. SORTING EXAMPLE

Moving ahead from our example of adding numbers we progress to a program that can sort a list of numbers using the tools that we have accumulated till now. Sorting can be ascending or descending like if the largest number comes at the top, followed by a smaller number and so on till the smallest number the sort will be called descending. The other order starting with the smallest number and ending at the largest is called ascending sort. This is a common problem and many algorithms have been developed to solve it. One simple algorithm is the bubble sort algorithm.

In this algorithm we compare consecutive numbers. If they are in required order e.g. if it is a descending sort and the first is larger than the second, then we leave them as it is and if they are not in order, we swap them. Then we do the same process for the next two numbers and so on till the last two are compared and possibly swapped.

A complete iteration is called a pass over the array. We need N passes at least in the simplest algorithm if N is the number of elements to be sorted. A finer algorithm is to check if any swap was done in this pass and stop as soon as a pass goes without a swap. The array is now sorted as every pair of elements is in order.

For example if our list of numbers is 60, 55, 45, and 58 and we want to sort them in ascending order, the first comparison will be of 60 and 55 and as the order will be reversed to 55 and 60. The next comparison will be of 60 and 45 and again the two will be swapped. The next comparison of 60 and 58 will also cause a swap. At the end of first pass the numbers will be in order of 55, 45, 58, and 60. Observe that the largest number has bubbled down to the bottom. Just like a bubble at bottom of water. In the next pass 55 and 45 will be swapped. 55 and 58 will not be swapped and 58 and 60 will also not be swapped. In the next pass there will be no swap as the elements are in order i.e. 45, 55, 58, and 60. The passes will be stopped as the last pass did not cause any swap. The application of bubble sort on these numbers is further explained with the following illustration.

State of Data	Swap Done	Swap Flag				
Pass 1		Off				
<table border="1"><tr><td>60</td><td>55</td><td>45</td><td>58</td></tr></table>	60	55	45	58	Yes	On
60	55	45	58			
<table border="1"><tr><td>55</td><td>60</td><td>45</td><td>58</td></tr></table>	55	60	45	58	Yes	On
55	60	45	58			
<table border="1"><tr><td>55</td><td>45</td><td>60</td><td>58</td></tr></table>	55	45	60	58	Yes	On
55	45	60	58			
Pass 2		Off				
<table border="1"><tr><td>55</td><td>45</td><td>58</td><td>60</td></tr></table>	55	45	58	60	Yes	On
55	45	58	60			
<table border="1"><tr><td>45</td><td>55</td><td>58</td><td>60</td></tr></table>	45	55	58	60	No	On
45	55	58	60			
<table border="1"><tr><td>45</td><td>55</td><td>58</td><td>60</td></tr></table>	45	55	58	60	No	On
45	55	58	60			
Pass 3		Off				
<table border="1"><tr><td>45</td><td>55</td><td>58</td><td>60</td></tr></table>	45	55	58	60	No	Off
45	55	58	60			
<table border="1"><tr><td>45</td><td>55</td><td>58</td><td>60</td></tr></table>	45	55	58	60	No	Off
45	55	58	60			
<table border="1"><tr><td>45</td><td>55</td><td>58</td><td>60</td></tr></table>	45	55	58	60	No	Off
45	55	58	60			
No more passes since swap flag is Off						

Example 3.3

```

001 ; sorting a list of ten numbers using bubble sort
002 [org 0x0100]
003     jmp start
004
005 data:    dw 60, 55, 45, 50, 40, 35, 25, 30, 10, 0
006 swap:   db 0
007
008 start:   mov bx, 0                ; initialize array index to zero
009         mov byte [swap], 0      ; rest swap flag to no swaps
010
011 loop1:   mov ax, [data+bx]        ; load number in ax
012         cmp ax, [data+bx+2]    ; compare with next number
013         jbe noswap             ; no swap if already in order
014
015         mov dx, [data+bx+2]    ; load second element in dx
016         mov [data+bx+2], ax    ; store first number in second
017         mov [data+bx], dx      ; store second number in first
018         mov byte [swap], 1     ; flag that a swap has been done
019
020 noswap:  add bx, 2                ; advance bx to next index
021         cmp bx, 18             ; are we at last index
022         jne loop1             ; if not compare next two
023
024         cmp byte [swap], 1     ; check if a swap has been done
025         je bsort              ; if yes make another pass
026
027         mov ax, 0x4c00         ; terminate program
028         int 0x21

```

003	The jump instruction is placed to skip over data.
006	The swap flag can be stored in a register but as an example it is stored in memory and also to extend the concept at a later stage.
011-012	One element is read in AX and it is compared with the next element because memory to memory comparisons are not allowed.
013	If the JBE is changed to JB, not only the unnecessary swap on equal will be performed, there will be a major algorithmic flaw due to a logical error as in the case of equal elements the algorithm will never stop. JBE won't swap in the case of equal elements.
015-017	The swap is done using DX and AX registers in such a way that the values are crossed. The code uses the information that one of the elements is already in the AX register.
021	This time BX is compared with 18 instead of 20 even though the number of elements is same. This is because we pick an element and compare it with the next element. When we pick the 9th element we compare it with the next element and this is the last comparison, since if we pick the 10th element we will compare it with the 11th element and there is no 11th element in our case.
024-025	If a swap is done we repeat the whole process for possible more swaps.

Inside the debugger we observe that the JBE is changed to JNA due to the same reason as discussed for JNE and JNZ. The passes change the data in the same manner as we presented in our illustration above. If JBE in the code is changed to JAE the sort will change from ascending to descending. For signed numbers we can use JLE and JGE respectively for ascending and descending sort.

To clarify the difference of signed and unsigned jumps we change the data array in the last program to include some negative numbers as well. When JBE will be used on this data, i.e. with unsigned interpretation of the data and an ascending sort, the negative numbers will come at the end after the largest positive number. However JLE will bring the negative numbers at the very start of the list to bring them in proper ascending order according to a signed interpretation, even though they are large in magnitude. The data used is shown as below.

```
data:          dw 60, 55, 45, 50, -40, -35, 25, 30, 10, 0
```

This data includes some signed numbers as well. The JBE instruction will treat this data as an unsigned number and will cater only for the magnitude ignoring the sign. If the program is loaded in the debugger, the numbers will appear in their hexadecimal equivalent. The two numbers -40 and -35 are especially important as they are represented as FFD8 and FFDD. This data is not telling whether it is signed or unsigned. Our interpretation will decide whether it is a very large unsigned number or a signed number in two's complement form.

If the sorting algorithm is applied on the above data with JBE as the comparison instruction to sort in ascending order with unsigned interpretation, observe the comparisons of the two numbers FFD8 and FFDD. For example it will decide that FFDD > FFD8 since the first is larger in magnitude. At the end of sorting FFDD will be at the end of the list being declared the largest number and FFD8 will precede it to be the second largest.

If however the comparison instruction is changed to JLE and sorting is done on the same data it works similarly except on the two numbers FFDD and FFD8. This time JLE declares them to be smaller than every other number and also declares FFDD < FFD8. At the end of sorting, FFDD is

Computer Architecture & Assembly Language Programming	Course Code: CS401
CS401@vu.edu.pk	VU

declared to be the smallest number followed by FFD8 and then 0000. This is in contrast to the last example where JBE was used. This happened because JLE interpreted our data as signed numbers, and as a signed number FFDD has its sign bit on signaling that it is a negative number in two's complement form which is smaller than 0000 and every positive number. However JBE did not give any significance to the sign bit and included it in the magnitude. Therefore it declared the negative numbers to be the largest numbers.

If the required interpretation was of signed numbers the result produced by JLE is correct and if the required interpretation was of unsigned numbers the result produced by JBE is correct. This is the very difference between signed and unsigned integers in higher level languages, where the compiler takes the responsibility of making the appropriate jump depending on the type of integer used. But it is only at this level that we can understand the actual mechanism going on. In assembly language, use of proper jump is the responsibility of the programmer, to convey the intentions to use the data as signed or as unsigned.

The remaining possibilities of signed descending sort and unsigned descending sort can be done on the same lines and are left as an exercise. Other conditional jumps work in the same manner and can be studied from the reference at the end. Several will be discussed in more detail when they are used in subsequent chapters.

EXERCISES

1. Which registers are changed by the CMP instruction?
2. What are the different types of jumps available? Describe position relative addressing.
3. If AX=8FFF and BX=0FFF and "cmp ax, bx" is executed, which of the following jumps will be taken? Each part is independent of others. Also give the value of Z, S, and C flags.
 - a. jg greater
 - b. jl smaller
 - c. ja above
 - d. jb below
4. Write a program to find the maximum number and the minimum number from an array of ten numbers.
5. Write a program to search a particular element from an array using binary search. If the element is found set AX to one and otherwise to zero.
6. Write a program to calculate the factorial of a number where factorial is defined as:

```
factorial(x) = x*(x-1)*(x-2)*...*1
factorial(0) = 1
```

Bit Manipulations

4.1. MULTIPLICATION ALGORITHM

With the important capability of decision making in our repertoire we move on to the discussion of an algorithm, which will help us uncover an important set of instructions in our processor used for bit manipulations.

Multiplication is a common process that we use, and we were trained to do in early schooling. Remember multiplying by a digit and then putting a cross and then multiplying with the next digit and putting two crosses and so on and summing the intermediate results in the end. Very familiar process but we never saw the process as an algorithm, and we need to see it as an algorithm to convey it to the processor.

To highlight the important thing in the algorithm we revise it on two 4bit binary numbers. The numbers are 1101 i.e. 13 and 0101 i.e. 5. The answer should be 65 or in binary 01000001. Observe that the answer is twice as long as the multiplier and the multiplicand. The multiplication is shown in the following figure.

```

1101 = 13
0101 = 5
-----
 1101
0000x
1101xx
0000xxx
-----
01000001 = 65

```

We take the first digit of the multiplier and multiply it with the multiplicand. As the digit is one the answer is the multiplicand itself. So we place the multiplicand below the bar. Before multiplying with the next digit a cross is placed at the right most place on the next line and the result is placed shifted one digit left. However since the digit is zero, the result is zero. Next digit is one, multiplying with which, the answer is 1101. We put two crosses on the next line at the right most positions and place the result there shifted two places to the left. The fourth digit is zero, so the answer 0000 is placed with three crosses to its right.

Observe the beauty of binary base, as no real multiplication is needed at the digit level. If the digit is 0 the answer is 0 and if the digit is 1 the answer is the multiplicand itself. Also observe that for every next digit in the multiplier the answer is written shifted one more place to the left. No shifting for the first digit, once for the second, twice for the third and thrice for the fourth one. Adding all the intermediate answers the result is 01000001=65 as desired. Crosses are treated as zero in this addition.

Before formulating the algorithm for this problem, we need some more instructions that can shift a number so that we use this instruction for our multiplicand shifting and also some way to check the bits of the multiplier one by one.

4.2. SHIFTING AND ROTATIONS

The set of shifting and rotation instructions is one of the most useful set in any processor's instruction set. They simplify really complex tasks to a very

neat and concise algorithm. The following shifting and rotation operations are available in our processor.

Shift Logical Right (SHR)

The shift logical right operation inserts a zero from the left and moves every bit one position to the right and copies the rightmost bit in the carry flag. Imagine that there is a pipe filled to capacity with eight balls. The pipe is open from both ends and there is a basket at the right end to hold anything dropping from there. The operation of shift logical right is to force a white ball from the left end. The operation is depicted in the following illustration.

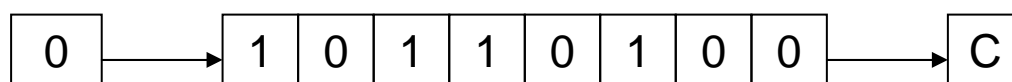

White balls represent zero bits while black balls represent one bits. Sixteen bit shifting is done the same way with a pipe of double capacity.

Shift Logical Left (SHL) / Shift Arithmetic Left (SAL)

The shift logical left operation is the exact opposite of shift logical right. In this operation the zero bit is inserted from the right and every bit moves one position to its left with the most significant bit dropping into the carry flag. Shift arithmetic left is just another name for shift logical left. The operation is again exemplified with the following illustration of ball and pipes.

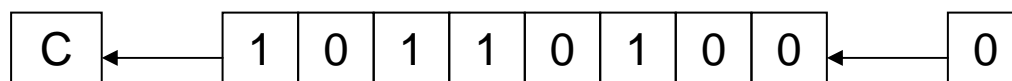

Shift Arithmetic Right (SAR)

A signed number holds the sign in its most significant bit. If this bit was one a logical right shifting will change the sign of this number because of insertion of a zero from the left. The sign of a signed number should not change because of shifting.

The operation of shift arithmetic right is therefore to shift every bit one place to the right with a copy of the most significant bit left at the most significant place. The bit dropped from the right is caught in the carry basket. The sign bit is retained in this operation. The operation is further illustrated below.

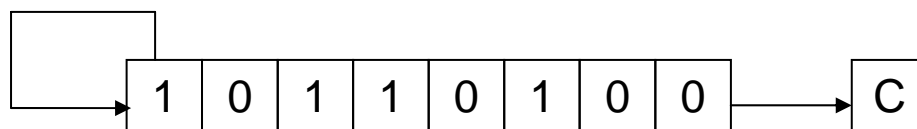

The left shifting operation is basically multiplication by 2 while the right shifting operation is division by two. However for signed numbers division by two can be accomplished by using shift arithmetic right and not shift logical right. The left shift operation is equivalent to multiplication except when an important bit is dropped from the left. The overflow flag will signal this condition if it occurs and can be checked with JO. For division by 2 of a signed number logical right shifting will give a wrong answer for a negative number as the zero inserted from the left will change its sign. To retain the sign flag and still effectively divide by two the shift arithmetic right instruction must be used on signed numbers.

Rotate Right (ROR)

In the rotate right operation every bit moves one position to the right and the bit dropped from the right is inserted at the left. This bit is also copied into the carry flag. The operation can be understood by imagining that the pipe used for shifting has been molded such that both ends coincide. Now when the first ball is forced to move forward, every ball moves one step forward with the last ball entering the pipe from its other end occupying the first ball's old position. The carry basket takes a snapshot of this ball leaving one end of the pipe and entering from the other.

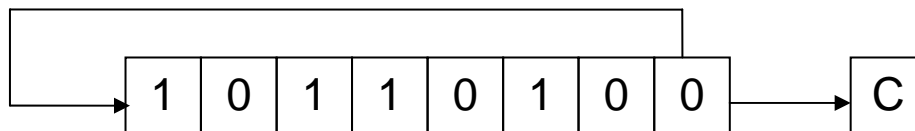

Rotate Left (ROL)

In the operation of rotate left instruction, the most significant bit is copied to the carry flag and is inserted from the right, causing every bit to move one position to the left. It is the reverse of the rotate right instruction. Rotation can be of eight or sixteen bits. The following illustration will make the concept clear using the same pipe and balls example.

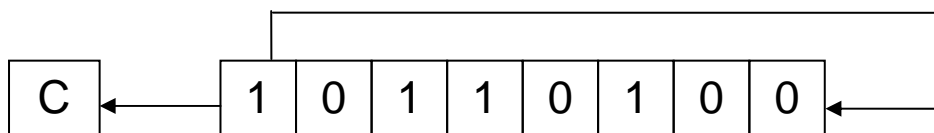

Rotate Through Carry Right (RCR)

In the rotate through carry right instruction, the carry flag is inserted from the left, every bit moves one position to the right, and the right most bit is dropped in the carry flag. Effectively this is a nine bit or a seventeen bit rotation instead of the eight or sixteen bit rotation as in the case of simple rotations.

Imagine the circular molded pipe as used in the simple rotations but this time the carry position is part of the circle between the two ends of the pipe. Pushing the carry ball from the left causes every ball to move one step to its right and the right most bit occupying the carry place. The idea is further illustrated below.

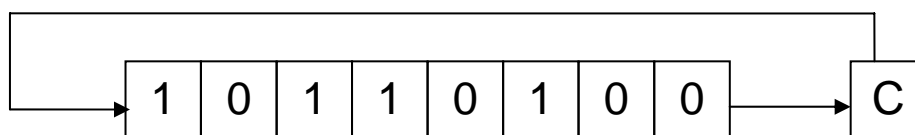

Rotate Through Carry Left (RCL)

The exact opposite of rotate through carry right instruction is the rotate through carry left instruction. In its operation the carry flag is inserted from the right causing every bit to move one location to its left and the most significant bit occupying the carry flag. The concept is illustrated below in the same manner as in the last example.

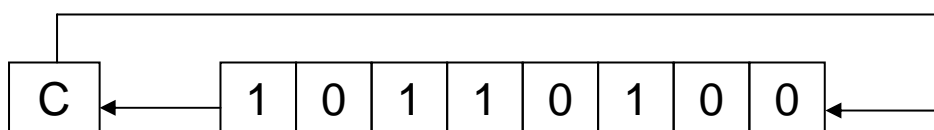

4.3. MULTIPLICATION IN ASSEMBLY LANGUAGE

In the multiplication algorithm discussed above we revised the way we multiplied number in lower classes, and gave an example of that method on binary numbers. We make a simple modification to the traditional algorithm before we proceed to formulate it in assembly language.

In the traditional algorithm we calculate all intermediate answers and then sum them to get the final answer. If we add every intermediate answer to accumulate the result, the result will be same in the end, except that we do not have to remember a lot of intermediate answers during the whole multiplication. The multiplication with the new algorithm is shown below.

1101 = 13	Accumulated Result	
0101 = 5		
-----		0 (Initial Value)
1101 = 13	0 + 13 = 13	
0000x = 0	13 + 0 = 13	
1101xx = 52	13 + 52 = 65	
0000xxx = 0	65 + 0 = 65 (Answer)	

We try to identify steps of our algorithm. First we set the result to zero. Then we check the right most bit of multiplier. If it is one add the multiplicand to the result, and if it is zero perform no addition. Left shift the multiplicand before the next bit of multiplier is tested. The left shifting of the multiplicand is performed regardless of the value of the multiplier's right most bit. Just like the crosses in traditional multiplication are always placed to mark the ones, tens, thousands, etc. places. Then check the next bit and if it is one add the shifted value of the multiplicand to the result. Repeat for as many digits as there are in the multiplier, 4 in our example. Formulating the steps of the algorithm we get:

- Shift the multiplier to the right.
- If CF=1 add the multiplicand to the result.
- Shift the multiplicand to the right.
- Repeat the algorithm 4 times.

For an 8bit multiplication the algorithm will be repeated 8 times and for a sixteen bit multiplication it will be repeated 16 times, whatever the size of the multiplier is.

The algorithm uses the fact that shifting right forces the right most bit to drop in the carry flag. If we test the carry flag using JC we are effectively testing the right most bit of the multiplier. Another shifting will cause the next bit to drop in the next iteration and so on. So our task of checking bits one by one is satisfied using the shift operation. There are many other methods to do this bit testing as well, however we exemplify one of the methods in this example.

In the first iteration there is no shifting just like there is no cross in traditional multiplication in the first pass. Therefore we placed the left shifting of the multiplicand after the addition step. However the right shifting of multiplier must be before the addition as the addition step's execution depends upon its result.

We introduce an assembly language program to perform this 4bit multiplication. The algorithm is extensible to more bits but there are a few complications, which are left to be discussed later. For now we do a 4bit multiplication to keep the algorithm simple.

Example 4.1	
01	; 4bit multiplication algorithm
02	[org 0x100]
03	jmp start
04	
05	multiplicand: db 13 ; 4bit multiplicand (8bit space)
06	multiplier: db 5 ; 4bit multiplier

```

07      result:      db      0              ; 8bit result
08
09      start:       mov     cl, 4          ; initialize bit count to four
10                      mov     bl, [multiplicand] ; load multiplicand in bl
11                      mov     dl, [multiplier]  ; load multiplier in dl
12
13      checkbit:    shr     dl, 1          ; move right most bit in carry
14                      jnc     skip         ; skip addition if bit is zero
15
16                      add     [result], bl    ; accumulate result
17
18      skip:       shl     bl, 1          ; shift multiplicand left
19                      dec     cl          ; decrement bit count
20                      jnz     checkbit      ; repeat if bits left
21
22                      mov     ax, 0x4c00    ; terminate program
23                      int     0x21

```

04-06 The numbers to be multiplied are constants for now. The multiplication is four bit so the answer is stored in an 8bit register. If the operands were 8bit the answer would be 16bit and if the operands were 16bit the answer would be 32bit. Since eight bits can fit in a byte we have used 4bit multiplication as our first example.

07 Since addition by zero means nothing we skip the addition step if the rightmost bit of the multiplier is zero. If the jump is not taken the shifted value of the multiplicand is added to the result.

14-16 The multiplicand is left shifted in every iteration regardless of the multiplier bit.

18 DEC is a new instruction but its operation should be immediately understandable with the knowledge gained till now. It simply subtracts one from its single operand.

19 The JNZ instruction causes the algorithm to repeat till any bits of the multiplier are left

20

Inside the debugger observe the working of the SHR and SHL instructions. The SHR instruction is effectively dividing its operand by two and the remainder is stored in the carry flag from where we test it. The SHL instruction is multiplying its operand by two so that it is added at one place more towards the left in the result.

4.4. EXTENDED OPERATIONS

We performed a 4bit multiplication to explain the algorithm however the real advantage of the computer is when we ask it to multiply large numbers, Numbers whose multiplication takes real time. If we have an 8bit number we can do the multiplication in word registers, but are we limited to word operations? What if we want to multiply 32bit or even larger numbers? We are certainly not limited. Assembly language only provides us the basic building blocks. We build a plaza out of these blocks, or a building, or a classic piece of architecture is only dependant upon our imagination. With our logic we can extend these algorithms as much as we want.

Our next example will be multiplication of 16bit numbers to produce a 32bit answer. However for a 32bit answer we need a way to shift a 32bit number and a way to add 32bit numbers. We cannot depend on 16bit shifting as we have 16 significant bits in our multiplicand and shifting any bit towards the left may drop a valuable bit causing a totally wrong result. A valuable bit means any bit that is one. Dropping a zero bit doesn't cause any difference. So we place the 16it number in 32bit space with the upper 16 bits zeroed so that the sixteen shift operations don't cause any valuable bit to drop. Even though the numbers were 16bit we need 32bit operations to multiply correctly.

To clarify this necessity, we take example of a number 40000 or 9C40 in hexadecimal. In binary it is represented as 1001110001000000. To multiply

by two we shift it one place to the left. The answer we get is 0011100010000000 and the left most one is dropped in the carry flag. The answer should be the 17bit number 0x13880 but it is 0x3880, which are 14464 in decimal instead of the expected 80000. We should be careful of this situation whenever shifting is used.

Extended Shifting

Using our basic shifting and rotation instructions we can effectively shift a 32bit number in memory word by word. We cannot shift the whole number at once since our architecture is limited to word operations. The algorithm we use consists of just two instructions and we name it extended shifting.

```
num1:    dd    40000
         shl   word [num1], 1
         rcl   word [num1+2], 1
```

The DD directive reserves a 32bit space in memory, however the value we placed there will fit in 16bits. So we can safely shift the number left 16 times. The least significant word is accessible at num1 and the most significant word is accessible at num1+2.

The two instructions are carefully crafted such that the first one shifts the lower word towards the left and the most significant bit of that word is dropped in carry. With the next instruction we push that dropped bit into the least significant bit of the next word effectively joining the two 16bit words. The final carry after the second instruction will be the most significant bit of the higher word, which for this number will always be zero.

The following illustration will clarify the concept. The pipe on the right contains the lower half and the pipe on the left contains the upper half. The first instruction forced a zero from the right into the lower half and the left most bit is saved in carry, and from there it is pushed into the upper half and the upper half is shifted as well.

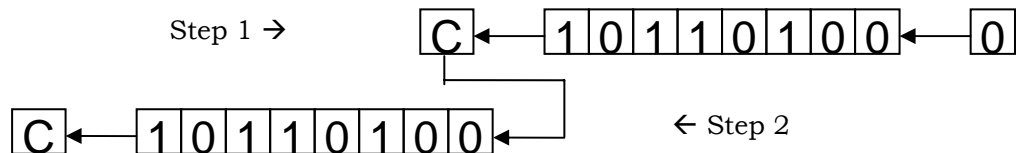

For shifting right the exact opposite is done however care must be taken to shift right the upper half first and then rotate through carry right the lower half for obvious reasons. The instructions to do this are.

```
num1:    dd    40000
         shr   word [num1+2], 1
         rcr   word [num1], 1
```

The same logic has worked. The shift placed the least significant bit of the upper half in the carry flag and it was pushed from right into the lower half. For a signed shift we would have used the shift arithmetic right instruction instead of the shift logical right instruction.

The extension we have done is not limited to 32bits. We can shift a number of any size say 1024 bits. The second instruction will be repeated a number of times and we can achieve the desired effect. Using two simple instructions we have increased the capability of the operation to effectively an unlimited number of bits. The actual limit is the available memory as even the segment limit can be catered with a little thought.

Extended Addition and Subtraction

We also needed 32bit addition for multiplication of 16bit numbers. The idea of extension is same here. However we need to introduce a new instruction at this place. The instruction is ADC or “add with carry.” Normal addition has two operands and the second operand is added to the first

operand. However ADC has three operands. The third implied operand is the carry flag. The ADC instruction is specifically placed for extending the capability of ADD. Numbers of any size can be added using a proper combination of ADD and ADC. All basic building blocks are provided for the assembly language programmer, and the programmer can extend its capabilities as much as needed by using these fine instructions in appropriate combinations.

Further clarifying the operation of ADC, consider an instruction “ADC AX, BX.” Normal addition would have just added BX to AX, however ADC first adds the carry flag to AX and then adds BX to AX. Therefore the last carry is also included in the result.

The algorithm should be apparent by now. The lower halves of the two numbers to be added are first added with a normal addition. For the upper halves a normal addition would lose track of a possible carry from the lower halves and the answer would be wrong. If a carry was generated it should go to the upper half. Therefore the upper halves are added with an addition with carry instruction.

Since one operand must be in register, ax is used to read the lower and upper halves of the source one by one. The destination is directly updated. The set of instructions goes here.

```

dest:      dd  40000
src:       dd  80000
           mov  ax, [src]
           add  word [dest], ax
           mov  ax, [src+2]
           adc  word [dest+2], ax

```

To further extend it more addition with carries will be used. However the carry from last addition will be wasted as there will always be a size limit where the results and the numbers are stored. This carry will remain in the carry flag to be tested for a possible overflow.

For subtraction the same logic will be used and just like addition with carry there is an instruction to subtract with borrows called SBB. Borrow in the name means the carry flag and is used just for clarity. Or we can say that the carry flag holds the carry for addition instructions and the borrow for subtraction instructions. Also the carry is generated at the 17th bit and the borrow is also taken from the 17th bit. Also there is no single instruction that needs borrow and carry in their independent meanings at the same time. Therefore it is logical to use the same flag for both tasks.

We extend subtraction with a very similar algorithm. The lower halves must be subtracted normally while the upper halves must be subtracted with a subtract with borrow instruction so that if the lower halves needed a borrow, a one is subtracted from the upper halves. The algorithm is as under.

```

dest:      dd  40000
src:       dd  80000
           mov  ax, [src]
           sub  word [dest], ax
           mov  ax, [src+2]
           sbb  word [dest+2], ax

```

Extended Multiplication

We use extended shifting and extended addition to formulate our algorithm to do extended multiplication. The multiplier is still stored in 16bits since we only need to check its bits one by one. The multiplicand however cannot be stored in 16bits otherwise on left shifting its significant bits might get lost. Therefore it has to be stored in 32bits and the shifting and addition used to accumulate the result must be 32bits as well.

Example 4.2

```

01      ; 16bit multiplication
02      [org 0x0100]
03          jmp     start
04
05      multiplicand: dd    1300          ; 16bit multiplicand 32bit space
06      multiplier:   dw    500          ; 16bit multiplier
07      result:      dd    0            ; 32bit result
08
09      start:       mov    cx, 16        ; initialize bit count to 16
10          mov    dx, [multiplier]     ; load multiplier in dx
11
12      checkbit:   shr    dx, 1         ; move right most bit in carry
13          jnc    skip                 ; skip addition if bit is zero
14
15          mov    ax, [multiplicand]
16          add   [result], ax          ; add less significant word
17          mov    ax, [multiplicand+2]
18          adc   [result+2], ax        ; add more significant word
19
20      skip:      shl    word [multiplicand], 1
21          rcl   word [multiplicand+2], 1 ; shift multiplicand left
22          dec   cx                    ; decrement bit count
23          jnz   checkbit              ; repeat if bits left
24
25          mov    ax, 0x4c00           ; terminate program
26          int   0x21

```

05-07	The multiplicand and the multiplier are stored in 32bit space while the multiplier is stored as a word.
10	The multiplier is loaded in DX where it will be shifted bit by bit. It can be directly shifted in memory as well.
15-18	The multiplicand is added to the result using extended 32bit addition.
20-21	The multiplicand is shifted left as a 32bit number using extended shifting operation.

The multiplicand will occupy the space from 0103-0106, the multiplier will occupy space from 0107-0108 and the result will occupy the space from 0109-010C. Inside the debugger observe the changes in these memory locations during the course of the algorithm. The extended shifting and addition operations provide the same effect as would be provided if there were 32bit addition and shifting operations available in the instruction set.

At the end of the algorithm the result memory locations contain the value 0009EB10 which is 65000 in decimal; the desired answer. Also observe that the number 00000514 which is 1300 in decimal, our multiplicand, has become 05140000 after being left shifted 16 times. Our extended shifting has given the same result as if a 32bit number is left shifted 16 times as a unit.

There are many other important applications of the shifting and rotation operations in addition to this example of the multiplication algorithm. More examples will come in coming chapters.

4.5. BITWISE LOGICAL OPERATIONS

The 8088 processor provides us with a few logical operations that operate at the bit level. The logical operations are the same as discussed in computer logic design; however our perspective will be a little different. The four basic operations are AND, OR, XOR, and NOT.

The important thing about these operations is that they are bitwise. This means that if “and ax, bx” instruction is given, then the operation of AND is applied on corresponding bits of AX and BX. There are 16 AND operations as a result; one for every bit of AX. Bit 0 of AX will be set if both its original value and Bit 0 of BX are set, bit 1 will be set if both its original value and Bit 1 of BX are set, and so on for the remaining bits. These operations are conducted in parallel on the sixteen bits. Similarly the operations of other logical operations are bitwise as well.

AND operation

AND performs the logical bitwise *and* of the two operands (byte or word) and returns the result to the destination operand. A bit in the result is set if both corresponding bits of the original operands are set; otherwise the bit is cleared as shown in the truth table. Examples are “and ax, bx” and “and byte [mem], 5.” All possibilities that are legal for addition are also legal for the AND operation. The different thing is the bitwise behavior of this operation.

X	Y	X and Y
0	0	0
0	1	0
1	0	0
1	1	1

OR operation

OR performs the logical bitwise “inclusive or” of the two operands (byte or word) and returns the result to the destination operand. A bit in the result is set if either or both corresponding bits in the original operands are set otherwise the result bit is cleared as shown in the truth table. Examples are “or ax, bx” and “or byte [mem], 5.”

X	Y	X or Y
0	0	0
0	1	1
1	0	1
1	1	1

XOR operation

XOR (Exclusive Or) performs the logical bitwise “exclusive or” of the two operands and returns the result to the destination operand. A bit in the result is set if the corresponding bits of the original operands contain opposite values (one is set, the other is cleared) otherwise the result bit is cleared as shown in the truth table. XOR is a very important operation due to the property that it is a reversible operation. It is used in many cryptography algorithms, image processing, and in drawing operations. Examples are “xor ax, bx” and “xor byte [mem], 5.”

X	Y	X xor Y
0	0	0
0	1	1
1	0	1
1	1	0

NOT operation

NOT inverts the bits (forms the one’s complement) of the byte or word operand. Unlike the other logical operations, this is a single operand instruction, and is not purely a logical operation in the sense the others are, but it is still traditionally counted in the same set. Examples are “not ax” and “not byte [mem], 5.”

4.6. MASKING OPERATIONS

Selective Bit Clearing

Another use of AND is to make selective bits zero in its destination operand. The source operand is loaded with a mask containing one at positions which are retain their old value and zero at positions which are to be zeroed. The effect of applying this operation on the destination with mask in the source is to clear the desired bits. This operation is called masking. For example if the lower nibble is to be cleared then the operation can be applied with F0 in the source. The upper nibble will retain its old value and the lower nibble will be cleared.

Selective Bit Setting

The operation can be used as a masking operation to set selective bits. The bits in the mask are cleared at positions which are to retain their values, and are set at positions which are to be set. For example to set the lower nibble of the destination operand, the operation should be applied with a mask of 0F in the source. The upper nibble will retain its value and the lower nibble will be set as a result.

Selective Bit Inversion

XOR can also be used as a masking operation to invert selective bits. The bits in the mask are cleared at positions, which are to retain their values, and are set at positions, which are to be inverted. For example to invert the lower nibble of the destination operand, the operand should be applied with a mask of 0F in the source. The upper nibble will retain its value and the lower nibble will be set as a result. Compare this with NOT which inverts everything. XOR on the other hand allows inverting selective bits.

Selective Bit Testing

AND can be used to check whether particular bits of a number are set or not. Previously we used shifting and JC to test bits one by one. Now we introduce another way to test bits, which is more powerful in the sense that any bit can be tested anytime and not necessarily in order. AND can be applied on a destination with a 1-bit in the desired position and a source, which is to be checked. If the destination is zero as a result, which can be checked with a JZ instruction, the bit at the desired position in the source was clear.

However the AND operation destroys the destination mask, which might be needed later as well. Therefore Intel provided us with another instruction analogous to CMP, which is non-destructive subtraction. This is the TEST instruction and is a non-destructive AND operation. It doesn't change the destination and only sets the flags according to the AND operation. By checking the flags, we can see if the desired bit was set or cleared.

We change our multiplication algorithm to use selective bit testing instead of checking bits one by one using the shifting operations.

Example 4.3	
01	<code>; 16bit multiplication using test for bit testing</code>
02	<code>[org 0x0100]</code>
03	<code>jmp start</code>
04	
05	<code>multiplicand: dd 1300 ; 16bit multiplicand 32bit space</code>
06	<code>multiplier: dw 500 ; 16bit multiplier</code>
07	<code>result: dd 0 ; 32bit result</code>
08	
09	<code>start: mov cl, 16 ; initialize bit count to 16</code>
10	<code>mov bx, 1 ; initialize bit mask</code>
11	
12	<code>checkbit: test bx, [multiplier] ; move right most bit in carry</code>
13	<code>jz skip ; skip addition if bit is zero</code>
14	
15	<code>mov ax, [multiplicand]</code>
16	<code>add [result], ax ; add less significant word</code>
17	<code>mov ax, [multiplicand+2]</code>
18	<code>adc [result+2], ax ; add more significant word</code>
19	
20	<code>skip: shl word [multiplicand], 1</code>
21	<code>rcl word [multiplicand+2], 1 ; shift multiplicand left</code>
22	<code>shl bx, 1 ; shift mask towards next bit</code>
23	<code>dec cl ; decrement bit count</code>
24	<code>jnz checkbit ; repeat if bits left</code>
25	
26	<code>mov ax, 0x4c00 ; terminate program</code>
27	<code>int 0x21</code>
12	The test instruction is used for bit testing. BX holds the mask and in every next iteration it is shifting left, as our concerned bit is now the next bit.
22-24	We can do without counting in this example. We can stop as soon as our mask in BX becomes zero. These are the small tricks that assembly allows us to do and optimize our code as a result.

Computer Architecture & Assembly Language Programming	Course Code: CS401
CS401@vu.edu.pk	VU

Inside the debugger observe that both the memory location and the mask in BX do not change as a result of TEST instruction. Also observe how our mask is shifting towards the left so that the next TEST instruction tests the next bit. In the end we get the same result of 0009EB10 as in the previous example.

EXERCISES

1. Write a program to swap every pair of bits in the AX register.
2. Give the value of the AX register and the carry flag after each of the following instructions.

```

stc
mov ax, <your rollnumber>
adc ah, <first character of your name>
cmc
xor ah, al
mov cl, 4
shr al, cl
rcr ah, cl

```

3. Write a program to swap the nibbles in each byte of the AX register.
4. Calculate the number of one bits in BX and complement an equal number of least significant bits in AX.
HINT: Use the XOR instruction
5. Write a program to multiply two 32bit numbers and store the answer in a 64bit location.
6. Declare a 32byte buffer containing random data. Consider for this problem that the bits in these 32 bytes are numbered from 0 to 255. Declare another byte that contains the starting bit number. Write a program to copy the byte starting at this starting bit number in the AX register. Be careful that the starting bit number may not be a multiple of 8 and therefore the bits of the desired byte will be split into two bytes.
7. AX contains a number between 0-15. Write code to complement the corresponding bit in BX. For example if AX contains 6; complement the 6th bit of BX.
8. AX contains a non-zero number. Count the number of ones in it and store the result back in AX. Repeat the process on the result (AX) until AX contains one. Calculate in BX the number of iterations it took to make AX one. For example BX should contain 2 in the following case:
AX = 1100 0101 1010 0011 (input – 8 ones)
AX = 0000 0000 0000 1000 (after first iteration – 1 one)
AX = 0000 0000 0000 0001 (after second iteration – 1 one) STOP

5

Subroutines

5.1. PROGRAM FLOW

Till now we have accumulated the very basic tools of assembly language programming. A very important weapon in our arsenal is the conditional jump instruction. During the course of last two chapters we used these tools to write two very useful algorithms of sorting and multiplication. The multiplication algorithm is useful even though there is a MUL instruction in the 8088 instruction set, which can multiply 8bit and 16bit operands. This is because of the extensibility of our algorithm, as it is not limited to 16bits and can do 32bit or 64bit multiplication with minor changes.

Both of these algorithms will be used a number of times in any program of a reasonable size and complexity. An application does not only need to multiply at a single point in code; it multiplies at a number of places. If multiplication or sorting is needed at 100 places in code, copying it 100 times is a totally infeasible solution. Maintaining such a code is an impossible task.

The straightforward solution to this problem using the concepts we have acquainted till now is to write the code at one place with a label, and whenever we need to sort we jump to this label. But there is problem with this logic, and the problem is that after sorting is complete how the processor will know where to go back. The immediate answer is to jump back to a label following the jump to bubble sort. But we have jumped to bubble sort from 100 places in code. Which of the 100 positions in code should we jump back? Jump back at the first invocation, but jump has a single fixed target. How will the second invocation work? The second jump to bubble sort will never have control back at the next line.

Instruction are tied to one another forming an execution thread, just like a knitted thread where pieces of cotton of different sizes are twisted together to form a thread. This thread of execution is our program. The jump instruction breaks this thread permanently, making a permanent diversion, like a turn on a highway. The conditional jump selects one of the two possible directions, like right or left turn on a road. So there is no concept of returning.

However there are roundabouts on roads as well that take us back from where we started after having traveled on the boundary of the round. This is the concept of a temporary diversion. Two or more permanent diversions can take us back from where we started, just like two or more road turns can take us back to the starting point, but they are still permanent diversions in their nature.

We need some way to implement the concept of temporary diversion in assembly language. We want to create a roundabout of bubble sort, another roundabout of our multiplication algorithm, so that we can enter into the roundabout whenever we need it and return back to wherever we left from after completing the round.

Program

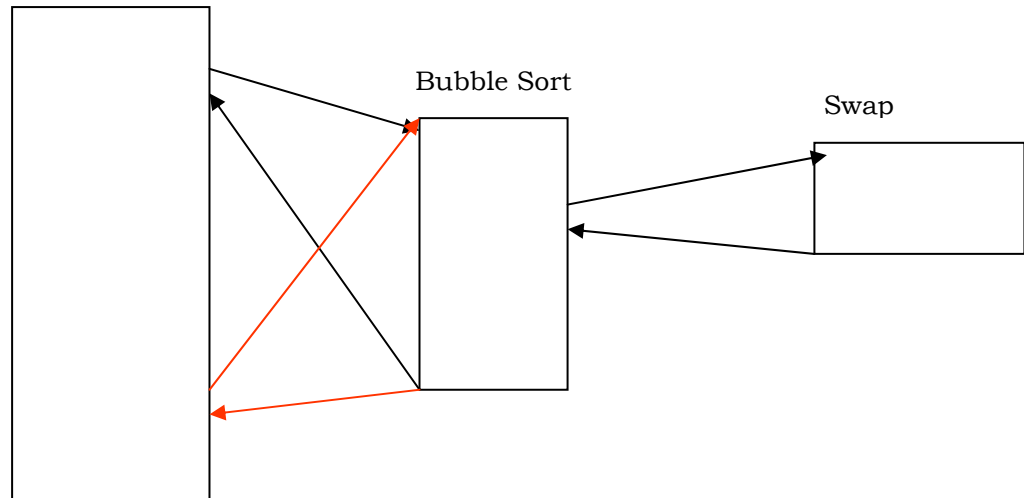

Key point in the above discussion is returning to where we left from, like a loop in a knitted thread. Diversion should be temporary and not permanent. The code of bubble sort written at one place, multiply at another, and we temporarily divert to that place, thus avoiding a repetition of code at a 100 places.

CALL and RET

In every processor, instructions are available to divert temporarily and to divert permanently. The instructions for permanent diversion in 8088 are the jump instructions, while the instruction for temporary diversion is the CALL instruction. The word call must be familiar to the readers from subroutine call in higher level languages. The CALL instruction allows temporary diversion and therefore reusability of code. Now we can place the code for bubble sort at one place and reuse it again and again. This was not possible with permanent diversion. Actually the 8088 permanent diversion mechanism can be tricked to achieve temporary diversion. However it is not possible without getting into a lot of trouble. The key idea in doing it this way is to use the jump instruction form that takes a register as argument. Therefore this is not impossible but this is not the way it is done.

The natural way to do this is to use the CALL instruction followed by a label, just like JMP is followed by a label. Execution will divert to the code following the label. Till now the operation has been similar to the JMP instruction. When the subroutine completes we need to return. The RET instruction is used for this purpose. The word return holds in its meaning that we are to return from where we came and need no explicit destination. Therefore RET takes no arguments and transfers control back to the instruction following the CALL that took us in this subroutine. The actual technical process that informs RET where to return will be discussed later after we have discussed the system stack.

CALL takes a label as argument and execution starts from that label, until the RET instruction is encountered and it takes execution back to the instruction following the CALL. Both the instructions are commonly used as a pair, however technically they are independent in their operation. The RET works regardless of the CALL and the CALL works regardless of the RET. If you CALL a subroutine it will not complain if there is no RET present and similarly if you RET without being called it won't complain. It is a logical pair and is used as a pair in every decent code. However sometimes we play tricks with the processor and we use CALL or RET alone. This will become clear when we need to play such tricks in later chapters.

Parameters

We intend to write the bubble sort code at one place and CALL it whenever needed. An immediately visible problem is that whenever we call this subroutine it will sort the same array in the same order. However in a real application we will need to sort various arrays of various sizes. We might sometimes need an ascending sort and descending at other times. Similarly our data may be signed or unsigned. Such pieces of information that may change from invocation to invocation and should be passed from the caller to the subroutine are called parameters.

There must be some way of passing these parameters to the subroutine. Revising the subroutine temporary flow breakage mechanism, the most straightforward way is to use registers. The CALL mechanism breaks the thread of execution and does not change registers, except IP which must change for processor to start executing at another place, and SP whose change will be discussed in detail later. Any of the other registers can hold parameters for the subroutine.

5.2. OUR FIRST SUBROUTINE

Now we want to modify the bubble sort code so that it works as a subroutine. We place a label at the start of bubble sort code, which works as the anchor point and will be used in the CALL instruction to call the subroutine. We also place a RET at the end of the algorithm to return from where we called the subroutine.

Example 5.1	
01	; bubble sort algorithm as a subroutine
02	[org 0x0100]
03	jmp start
04	
05	data: dw 60, 55, 45, 50, 40, 35, 25, 30, 10, 0
06	swap: db 0
07	
08	bubblesort: dec cx ; last element not compared
09	shl cx, 1 ; turn into byte count
10	
11	mainloop: mov si, 0 ; initialize array index to zero
12	mov byte [swap], 0 ; reset swap flag to no swaps
13	
14	innerloop: mov ax, [bx+si] ; load number in ax
15	cmp ax, [bx+si+2] ; compare with next number
16	jbe noswap ; no swap if already in order
17	
18	mov dx, [bx+si+2] ; load second element in dx
19	mov [bx+si], dx ; store first number in second
20	mov [bx+si+2], ax ; store second number in first
21	mov byte [swap], 1 ; flag that a swap has been done
22	
23	noswap: add si, 2 ; advance si to next index
24	cmp si, cx ; are we at last index
25	jne innerloop ; if not compare next two
26	
27	cmp byte [swap], 1 ; check if a swap has been done
28	je mainloop ; if yes make another pass
29	
30	ret ; go back to where we came from
31	
32	start: mov bx, data ; send start of array in bx
33	mov cx, 10 ; send count of elements in cx
34	call bubblesort ; call our subroutine
35	
36	mov ax, 0x4c00 ; terminate program
37	int 0x21
08-09	The routine has received the count of elements in CX. Since it makes one less comparison than the number of elements it decrements it. Then it multiplies it by two since this a word array and each element

14	takes two bytes. Left shifting has been used to multiply by two. Base+index+offset addressing has been used. BX holds the start of array, SI the offset into it and an offset of 2 when the next element is to be read. BX can be directly changed but then a separate counter would be needed, as SI is directly compared with CX in our case.
32-37	The code starting from the start label is our main program analogous to the main in the C language. BX and CX hold our parameters for the bubblesort subroutine and the CALL is made to invoke the subroutine.

Inside the debugger we observe the same unsigned data that we are so used to now. The number 0103 is passed via BX to the subroutine which is the start of our data and the number 000A via CX which is the number of elements in our data. If we step over the CALL instruction we see our data sorted in a single step and we are at the termination instructions. The processor has jumped to the bubblesort routine, executed it to completion, and returned back from it but the process was hidden due to the step over command. If however we trace into the CALL instruction, we land at the first instruction of our routine. At the end of the routine, when the RET instruction is executed, we immediately land back to our termination instructions, to be precise the instruction following the CALL.

Also observe that with the CALL instruction SP is decremented by two from FFFE to FFFC, and the stack windows shows 0150 at its top. As the RET is executed SP is recovered and the 0150 is also removed from the stack. Match it with the address of the instruction following the CALL which is 0150 as well. The 0150 removed from the stack by the RET instruction has been loaded into the IP register thereby resuming execution from address 0150. CALL placed where to return on the stack for the RET instruction. The stack is automatically used with the CALL and RET instructions. Stack will be explained in detail later, however the idea is that the one who is departing stores the address to return at a known place. This is the place using which CALL and RET coordinate. How this placed is actually used by the CALL and RET instructions will be described after the stack is discussed.

After emphasizing reusability so much, it is time for another example which uses the same bubblesort routine on two different arrays of different sizes.

Example 5.2	
01	; bubble sort subroutine called twice
02	[org 0x0100]
03	jmp start
04	
05	data: dw 60, 55, 45, 50, 40, 35, 25, 30, 10, 0
06	data2: dw 328, 329, 898, 8923, 8293, 2345, 10, 877, 355, 98
07	dw 888, 533, 2000, 1020, 30, 200, 761, 167, 90, 5
08	swap: db 0
09	
10	bubblesort: dec cx ; last element not compared
11	shl cx, 1 ; turn into byte count
12	
13	mainloop: mov si, 0 ; initialize array index to zero
14	mov byte [swap], 0 ; reset swap flag to no swaps
15	
16	innerloop: mov ax, [bx+si] ; load number in ax
17	cmp ax, [bx+si+2] ; compare with next number
18	jbe noswap ; no swap if already in order
19	
20	mov dx, [bx+si+2] ; load second element in dx
21	mov [bx+si], dx ; store first number in second
22	mov [bx+si+2], ax ; store second number in first
23	mov byte [swap], 1 ; flag that a swap has been done
24	
25	noswap: add si, 2 ; advance si to next index

26		cmp si, cx	; are we at last index
27		jne innerloop	; if not compare next two
28			
29		cmp byte [swap], 1	; check if a swap has been done
30		je mainloop	; if yes make another pass
31			
32		ret	; go back to where we came from
33			
34	start:	mov bx, data	; send start of array in bx
35		mov cx, 10	; send count of elements in cx
36		call bubblesort	; call our subroutine
37			
38		mov bx, data2	; send start of array in bx
39		mov cx, 20	; send count of elements in cx
40		call bubblesort	; call our subroutine again
41			
42		mov ax, 0x4c00	; terminate program
43		int 0x21	

05-07	There are two different data arrays declared. One of 10 elements and the other of 20 elements. The second array is declared on two lines, where the second line is continuation of the first. No additional label is needed since they are situated consecutively in memory.
34-40	The other change is in the main where the bubblesort subroutine is called twice, once on the first array and once on the second.

Inside the debugger observe that stepping over the first call, the first array is sorted and stepping over the second call the second array is sorted. If however we step in SP is decremented and the stack holds 0178 which is the address of the instruction following the call. The RET consumes that 0178 and restores SP. The next CALL places 0181 on the stack and SP is again decremented. The RET consumes this number and execution resumes from the instruction at 0181. This is the coordinated function of CALL and RET using the stack.

In both of the above examples, there is a shortcoming. The subroutine to sort the elements is destroying the registers AX, CX, DX, and SI. That means that the caller of this routine has to make sure that it does not hold any important data in these registers before calling this function, because after the call has returned the registers will be containing meaningless data for the caller. With a program containing thousands of subroutines expecting the caller to remember the set of modified registers for each subroutine is unrealistic and unreasonable. Also registers are limited in number, and restricting the caller on the use of register will make the caller's job very tough. This shortcoming will be removed using the very important system stack.

5.3. STACK

Stack is a data structure that behaves in a first in last out manner. It can contain many elements and there is only one way in and out of the container. When an element is inserted it sits on top of all other elements and when an element is removed the one sitting at top of all others is removed first. To visualize the structure consider a test tube and put some balls in it. The second ball will come above the first and the third will come above the second. When a ball is taken out only the one at the top can be removed. The operation of placing an element on top of the stack is called pushing the element and the operation of removing an element from the top of the stack is called popping the element. The last thing pushed is popped out first; the last in first out behavior.

We can peek at any ball inside the test tube but we cannot remove it without removing every ball on top of it. Similarly we can read any element from the stack but cannot remove it without removing everything above it. The stack operations of pushing and popping only work at the top of the

Computer Architecture & Assembly Language Programming	Course Code: CS401
CS401@vu.edu.pk	VU

stack. This top of stack is contained in the SP register. The physical address of the stack is obtained by the SS:SP combination. The stack segment registers tells where the stack is located and the stack pointer marks the top of stack inside this segment.

Whenever an element is pushed on the stack SP is decremented by two as the 8088 stack works on word sized elements. Single bytes cannot be pushed or popped from the stack. Also it is a decrementing stack. Another possibility is an incrementing stack. A decrementing stack moves from higher addresses to lower addresses as elements are added in it while an incrementing stack moves from lower addresses to higher addresses as elements are added. There is no special reason or argument in favor of one or another, and more or less depends on the choice of the designers. Another processor 8051 by the same manufacturer has an incrementing stack while 8088 has a decrementing one.

Memory is like a shelf numbered as zero at the top and the maximum at the bottom. If a decrementing stack starts at shelf 5, the first item is placed in shelf 5, the next item is placed in shelf 4, the next in shelf 3 and so on. The operations of placing items on the stack and removing them from there are called push and pop. The push operation copies its operand on the stack, while the pop operation makes a copy from the top of the stack into its operand. When an item is pushed on a decrementing stack, the top of the stack is first decremented and the element is then copied into this space. With a pop the element at the top of the stack is copied into the pop operand and the top of stack is incremented afterwards.

The basic use of the stack is to save things and recover from there when needed. For example we discussed the shortcoming in our last example that it destroyed the caller's registers, and the callers are not supposed to remember which registers are destroyed by the thousand routines they use. Using the stack the subroutine can save the caller's value of the registers on the stack, and recover them from there before returning. Meanwhile the subroutine can freely use the registers. From the caller's point of view if the registers contain the same value before and after the call, it doesn't matter if the subroutine used them meanwhile.

Similarly during the CALL operation, the current value of the instruction pointer is automatically saved on the stack, and the destination of CALL is loaded in the instruction pointer. Execution therefore resumes from the destination of CALL. When the RET instruction is executed, it recovers the value of the instruction pointer from the stack. The next instruction executed is therefore the one following the CALL. Observe how playing with the instruction pointer affects the program flow.

There is a form of the RET instruction called "RET n" where n is a numeric argument. After performing the operation of RET, it further increments the stack pointer by this number, i.e. SP is first incremented by two and then by n. Its function will become clear when parameter passing is discussed.

Now we describe the operation of the stack in CALL and RET with an example. The top of stack stored in the stack pointer is initialized at 2000. The space above SP is considered empty and free. When the stack pointer is decremented by two, we took a word from the empty space and can use it for our purpose. The unit of stack operations is a word. Some instructions push multiple words; however byte pushes cannot be made. Now the value 017B is stored in the word reserved on the stack. The RET will copy this value in the instruction pointer and increment the stack pointer by two making it 2000 again, thereby reverting the operation of CALL.

This is how CALL and RET behave for near calls. There is also a far version of these functions when the target routine is in another segment. This version of CALL takes a segment offset pair just like the far jump instruction. The CALL will push both the segment and the offset on the stack in this case, followed by loading CS and IP with the values given in the instruction.

The corresponding instruction RETF will pop the offset in the instruction pointer followed by popping the segment in the code segment register.

Apart from CALL and RET, the operations that use the stack are PUSH and POP. Two other operations that will be discussed later are INT and IRET. Regarding the stack, the operation of PUSH is similar to CALL however with a register other than the instruction pointer. For example “push ax” will push the current value of the AX register on the stack. The operation of PUSH is shown below.

```
SP ← SP - 2
[SP] ← AX
```

The operation of POP is the reverse of this. A copy of the element at the top of the stack is made in the operand, and the top of the stack is incremented afterwards. The operation of “pop ax” is shown below.

```
AX ← [SP]
SP ← SP + 2
```

Making corresponding PUSH and POP operations is the responsibility of the programmer. If “push ax” is followed by “pop dx” effectively copying the value of the AX register in the DX register, the processor won't complain. Whether this sequence is logically correct or not should be ensured by the programmer. For example when PUSH and POP are used to save and restore registers from the stack, order must be correct so that the saved value of AX is reloaded in the AX register and not any other register. For this the order of POP operations need to be the reverse of the order of PUSH operations.

Now we consider another example that is similar to the previous examples, however the code to swap the two elements has been extracted into another subroutine, so that the formation of stack can be observed during nested subroutine calls.

Example 5.3	
01	; bubble sort subroutine using swap subroutine
02	[org 0x0100]
03	jmp start
04	
05	data: dw 60, 55, 45, 50, 40, 35, 25, 30, 10, 0
06	data2: dw 328, 329, 898, 8923, 8293, 2345, 10, 877, 355, 98
07	dw 888, 533, 2000, 1020, 30, 200, 761, 167, 90, 5
08	swapflag: db 0
09	
10	swap: mov ax, [bx+si] ; load first number in ax
11	xchg ax, [bx+si+2] ; exchange with second number
12	mov [bx+si], ax ; store second number in first
13	ret ; go back to where we came from
14	
15	bubblesort: dec cx ; last element not compared
16	shl cx, 1 ; turn into byte count
17	
18	mainloop: mov si, 0 ; initialize array index to zero
19	mov byte [swapflag], 0 ; reset swap flag to no swaps
20	
21	innerloop: mov ax, [bx+si] ; load number in ax
22	cmp ax, [bx+si+2] ; compare with next number
23	jbe noswap ; no swap if already in order
24	
25	call swap ; swaps two elements
26	mov byte [swapflag], 1 ; flag that a swap has been done
27	
28	noswap: add si, 2 ; advance si to next index
29	cmp si, cx ; are we at last index
30	jne innerloop ; if not compare next two
31	
32	cmp byte [swapflag], 1 ; check if a swap has been done
33	je mainloop ; if yes make another pass
34	ret ; go back to where we came from
35	
36	start: mov bx, data ; send start of array in bx
37	mov cx, 10 ; send count of elements in cx

38	call bubblesort	; call our subroutine
39		
40	mov bx, data2	; send start of array in bx
41	mov cx, 20	; send count of elements in cx
42	call bubblesort	; call our subroutine again
43		
44	mov ax, 0x4c00	; terminate program
45	int 0x21	
11	A new instruction XCHG has been introduced. The instruction swaps its source and its destination operands however at most one of the operands could be in memory, so the other has to be loaded in a register. The instruction has reduced the code size by one instruction.	
13	The RET at the end of swap makes it a subroutine.	

Inside the debugger observe the use of stack by CALL and RET instructions, especially the nested CALL.

5.4. SAVING AND RESTORING REGISTERS

The subroutines we wrote till now have been destroying certain registers and our calling code has been carefully written to not use those registers. However this cannot be remembered for a good number of subroutines. Therefore our subroutines need to implement some mechanism of retaining the callers' value of any registers used.

The trick is to use the PUSH and POP operations and save the callers' value on the stack and recover it from there on return. Our swap subroutine destroyed the AX register while the bubblesort subroutine destroyed AX, CX, and SI. BX was not modified in the subroutine. It had the same value at entry and at exit; it was only used by the subroutine. Our next example improves on the previous version by saving and restoring any registers that it will modify using the PUSH and POP operations.

Example 5.4		
01	; bubble sort and swap subroutines saving and restoring registers	
02	[org 0x0100]	
03	jmp	start
04		
05	data:	dw 60, 55, 45, 50, 40, 35, 25, 30, 10, 0
06	data2:	dw 328, 329, 898, 8923, 8293, 2345, 10, 877, 355, 98
07		dw 888, 533, 2000, 1020, 30, 200, 761, 167, 90, 5
08	swapflag:	db 0
09		
10	swap:	push ax ; save old value of ax
11		
12		mov ax, [bx+si] ; load first number in ax
13		xchg ax, [bx+si+2] ; exchange with second number
14		mov [bx+si], ax ; store second number in first
15		
16		pop ax ; restore old value of ax
17		ret ; go back to where we came from
18		
19	bubblesort:	push ax ; save old value of ax
20		push cx ; save old value of cx
21		push si ; save old value of si
22		
23		dec cx ; last element not compared
24		shl cx, 1 ; turn into byte count
25		
26	mainloop:	mov si, 0 ; initialize array index to zero
27		mov byte [swapflag], 0 ; reset swap flag to no swaps
28		
29	innerloop:	mov ax, [bx+si] ; load number in ax
30		cmp ax, [bx+si+2] ; compare with next number
31		jbe noswap ; no swap if already in order
32		

33 34 35 36 37 38 39 40 41 42 43 44 45 46 47 48 49 50 51 52 53 54 55 56 57	<pre> call swap ; swaps two elements mov byte [swapflag], 1 ; flag that a swap has been done noswap: add si, 2 ; advance si to next index cmp si, cx ; are we at last index jne innerloop ; if not compare next two cmp byte [swapflag], 1 ; check if a swap has been done je mainloop ; if yes make another pass pop si ; restore old value of si pop cx ; restore old value of cx pop ax ; restore old value of ax ret ; go back to where we came from start: mov bx, data ; send start of array in bx mov cx, 10 ; send count of elements in cx call bubblesort ; call our subroutine mov bx, data2 ; send start of array in bx mov cx, 20 ; send count of elements in cx call bubblesort ; call our subroutine again mov ax, 0x4c00 ; terminate program int 0x21 </pre>
19-21	<p>When multiple registers are pushed, order is very important. If AX, CX, and SI are pushed in this order, they must be popped in the reverse order of SI, CX, and AX. This is again because the stack behaves in a Last In First Out manner.</p>

Inside the debugger we can observe that the registers before and after the CALL operation are exactly identical. Effectively the caller can assume the registers are untouched. By tracing into the subroutines we can observe how their value is saved on the stack by the PUSH instructions and recovered from their before exit. Saving and restoring registers this way in subroutines is a standard way and must be followed.

PUSH

PUSH decrements SP (the stack pointer) by two and then transfers a word from the source operand to the top of stack now pointed to by SP. PUSH often is used to place parameters on the stack before calling a procedure; more generally, it is the basic means of storing temporary data on the stack.

POP

POP transfers the word at the current top of stack (pointed to by SP) to the destination operand and then increments SP by two to point to the new top of stack. POP can be used to move temporary variables from the stack to registers or memory.

Observe that the operand of PUSH is called a source operand since the data is moving to the stack from the operand, while the operand of POP is called destination since data is moving from the stack to the operand.

CALL

CALL activates an out-of-line procedure, saving information on the stack to permit a RET (return) instruction in the procedure to transfer control back to the instruction following the CALL. For an intra segment direct CALL, SP is decremented by two and IP is pushed onto the stack. The target procedure's relative displacement from the CALL instruction is then added to the instruction pointer. For an inter segment direct CALL, SP is decremented by two, and CS is pushed onto the stack. CS is replaced by the segment word contained in the instruction. SP again is decremented by two. IP is pushed onto the stack and replaced by the offset word in the instruction.

Computer Architecture & Assembly Language Programming	Course Code: CS401
CS401@vu.edu.pk	VU

The out-of-line procedure is the temporary division, the concept of roundabout that we discussed. Near calls are also called intra segment calls, while far calls are called inter-segment calls. There are also versions that are called indirect calls; however they will be discuss later when they are used.

RET

RET (Return) transfers control from a procedure back to the instruction following the CALL that activated the procedure. RET pops the word at the top of the stack (pointed to by register SP) into the instruction pointer and increments SP by two. If RETF (inter segment RET) is used the word at the top of the stack is popped into the IP register and SP is incremented by two. The word at the new top of stack is popped into the CS register, and SP is again incremented by two. If an optional pop value has been specified, RET adds that value to SP. This feature may be used to discard parameters pushed onto the stack before the execution of the CALL instruction.

5.5. PARAMETER PASSING THROUGH STACK

Due to the limited number of registers, parameter passing by registers is constrained in two ways. The maximum parameters a subroutine can receive are seven when all the general registers are used. Also, with the subroutines are themselves limited in their use of registers, and this limited increases when the subroutine has to make a nested call thereby using certain registers as its parameters. Due to this, parameter passing by registers is not expandable and generalizable. However this is the fastest mechanism available for passing parameters and is used where speed is important.

Considering stack as an alternate, we observe that whatever data is placed there, it stays there, and across function calls as well. For example the bubble sort subroutine needs an array address and the count of elements. If we place both of these on the stack, and call the subroutine afterwards, it will stay there. The subroutine is invoked with its return address on top of the stack and its parameters beneath it.

To access the arguments from the stack, the immediate idea that strikes is to pop them off the stack. And this is the only possibility using the given set of information. However the first thing popped off the stack would be the return address and not the arguments. This is because the arguments were first pushed on the stack and the subroutine was called afterwards. The arguments cannot be popped without first popping the return address. If a heaving thing falls on someone's leg, the heavy thing is removed first and the leg is not pulled out to reduce the damage. Same is the case with our parameters on which the return address has fallen.

To handle this using PUSH and POP, we must first pop the return address in a register, then pop the operands, and push the return address back on the stack so that RET will function normally. However so much effort doesn't seem to pay back the price. Processor designers should have provided a logical and neat way to perform this operation. They did provided a way and infact we will do this without introducing any new instruction.

Recall that the default segment association of the BP register is the stack segment and the reason for this association had been deferred for now. The reason is to peek inside the stack using the BP register and read the parameters without removing them and without touching the stack pointer. The stack pointer could not be used for this purpose, as it cannot be used in an effective address. It is automatically used as a pointer and cannot be explicitly used. Also the stack pointer is a dynamic pointer and sometimes changes without telling us in the background. It is just that whenever we touch it, it is where we expect it to be. The base pointer is provided as a replacement of the stack pointer so that we can peek inside the stack without modifying the structure of the stack.

When the bubble sort subroutine is called, the stack pointer is pointing to the return address. Two bytes below it is the second parameter and four bytes below is the first parameter. The stack pointer is a reference point to these parameters. If the value of SP is captured in BP, then the return address is located at [bp+0], the second parameter is at [bp+2], and the first parameter is at [bp+4]. This is because SP and BP both had the same value and they both defaulted to the same segment, the stack segment.

This copying of SP into BP is like taking a snapshot or like freezing the stack at that moment. Even if more pushes are made on the stack decrementing the stack pointer, our reference point will not change. The parameters will still be accessible at the same offsets from the base pointer. If however the stack pointer increments beyond the base pointer, the references will become invalid. The base pointer will act as the datum point to access our parameters. However we have destroyed the original value of BP in the process, and this will cause problems in nested calls where both the outer and the inner subroutines need to access their own parameters. The outer subroutine will have its base pointer destroyed after the call and will be unable to access its parameters.

To solve both of these problems, we reach at the standard way of accessing parameters on the stack. The first two instructions of any subroutines accessing its parameters from the stack are given below.

```
push bp
mov bp, sp
```

As a result our datum point has shifted by a word. Now the old value of BP will be contained in [bp] and the return address will be at [bp+2]. The second parameters will be [bp+4] while the first one will be at [bp+6]. We give an example of bubble sort subroutine using this standard way of argument passing through stack.

Example 5.5	
01	; bubble sort subroutine taking parameters from stack
02	[org 0x0100]
03	jmp start
04	
05	data: dw 60, 55, 45, 50, 40, 35, 25, 30, 10, 0
06	data2: dw 328, 329, 898, 8923, 8293, 2345, 10, 877, 355, 98
07	dw 888, 533, 2000, 1020, 30, 200, 761, 167, 90, 5
08	swapflag: db 0
09	
10	bubblesort: push bp ; save old value of bp
11	mov bp, sp ; make bp our reference point
12	push ax ; save old value of ax
13	push bx ; save old value of bx
14	push cx ; save old value of cx
15	push si ; save old value of si
16	
17	mov bx, [bp+6] ; load start of array in bx
18	mov cx, [bp+4] ; load count of elements in cx
19	dec cx ; last element not compared
20	shl cx, 1 ; turn into byte count
21	
22	mainloop: mov si, 0 ; initialize array index to zero
23	mov byte [swapflag], 0 ; reset swap flag to no swaps
24	
25	innerloop: mov ax, [bx+si] ; load number in ax
26	cmp ax, [bx+si+2] ; compare with next number
27	jbe noswap ; no swap if already in order
28	
29	xchg ax, [bx+si+2] ; exchange ax with second number
30	mov [bx+si], ax ; store second number in first
31	mov byte [swapflag], 1 ; flag that a swap has been done
32	
33	noswap: add si, 2 ; advance si to next index
34	cmp si, cx ; are we at last index
35	jne innerloop ; if not compare next two
36	

```

37             cmp byte [swapflag], 1 ; check if a swap has been done
38             je  mainloop           ; if yes make another pass
39
40             pop si                  ; restore old value of si
41             pop cx                  ; restore old value of cx
42             pop bx                  ; restore old value of bx
43             pop ax                  ; restore old value of ax
44             pop bp                  ; restore old value of bp
45             ret 4                   ; go back and remove two params
46
47     start:   mov ax, data
48             push ax                 ; place start of array on stack
49             mov ax, 10
50             push ax                 ; place element count on stack
51             call bubblesort         ; call our subroutine
52
53             mov ax, data2
54             push ax                 ; place start of array on stack
55             mov ax, 20
56             push ax                 ; place element count on stack
57             call bubblesort         ; call our subroutine again
58
59             mov ax, 0x4c00          ; terminate program
60             int 0x21

```

11 The value of the stack pointer is captured in the base pointer. With further pushes SP will change but BP will not and therefore we will read parameters from bp+4 and bp+6.

45 The form of RET that takes an argument is used causing four to be added to SP after the return address has been popped in the instruction pointer. This will effectively discard the parameters that are still there on the stack.

47-50 We push the address of the array we want to sort followed by the count of elements. As immediate cannot be directly pushed in the 8088 architecture, we first load it in the AX register and then push the AX register on the stack.

Inside the debugger, concentrate on the operation of BP and the stack. The parameters are placed on the stack by the caller, the subroutine accesses them using the base pointer, and the special form of RET removes them without any extra instruction. The value of stack pointer of FFF6 is turned into FFFE by the RET instruction. This was the value in SP before any of the parameters was pushed.

Stack Clearing by Caller or Callee

Parameters pushed for a subroutine are a waste after the subroutine has returned. They have to be cleared from the stack. Either of the caller and the callee can take the responsibility of clearing them from there. If the callee has to clear the stack it cannot do this easily unless RET n exists. That is why most general processors have this instruction. Stack clearing by the caller needs an extra instruction on behalf of the caller after every call made to the subroutine, unnecessarily increasing instructions in the program. If there are thousand calls to a subroutine the code to clear the stack is repeated a thousand times. Therefore the prevalent convention in most high level languages is stack clearing by the callee; even though the other convention is still used in some languages.

If RET n is not available, stack clearing by the callee is a complicated process. It will have to save the return address in a register, then remove the parameters, and then place back the return address so that RET will function. When this instruction was introduced in processors, only then high level language designers switched to stack clearing by the callee. This is also exactly why RET n adds n to SP after performing the operation of RET. The other way around would be totally useless for our purpose. Consider the stack condition at the time of RET and this will become clear why this will be

useless. Also observe that RET n has discarded the arguments rather than popping them as they were no longer of any use either of the caller or the callee.

The strong argument in favour of callee cleared stacks is that the arguments were placed on the stack for the subroutine, the caller did not need them for itself, so the subroutine is responsible for removing them. Removing the arguments is important as if the stack is not cleared or is partially cleared the stack will eventually become full, SP will reach 0, and thereafter wraparound producing unexpected results. This is called stack overflow. Therefore clearing anything placed on the stack is very important.

5.6. LOCAL VARIABLES

Another important role of the stack is in the creation of local variables that are only needed while the subroutine is in execution and not afterwards. They should not take permanent space like global variables. Local variables should be created when the subroutine is called and discarded afterwards. So that the space used by them can be reused for the local variables of another subroutine. They only have meaning inside the subroutine and no meaning outside it.

The most convenient place to store these variables is the stack. We need some special manipulation of the stack for this task. We need to produce a gap in the stack for our variables. This is explained with the help of the swapflag in the bubble sort example.

The swapflag we have declared as a word occupying space permanently is only needed by the bubble sort subroutine and should be a local variable. Actually the variable was introduced with the intent of making it a local variable at this time. The stack pointer will be decremented by an extra two bytes thereby producing a gap in which a word can reside. This gap will be used for our temporary, local, or automatic variable; however we name it. We can decrement it as much as we want producing the desired space, however the decrement must be by an even number, as the unit of stack operation is a word. In our case we needed just one word. Also the most convenient position for this gap is immediately after saving the value of SP in BP. So that the same base pointer can be used to access the local variables as well; this time using negative offsets. The standard way to start a subroutine which needs to access parameters and has local variables is as under.

```
push bp
mov  bp, sp
sub  sp, 2
```

The gap could have been created with a dummy push, but the subtraction makes it clear that the value pushed is not important and the gap will be used for our local variable. Also gap of any size can be created in a single instruction with subtraction. The parameters can still be accessed at bp+4 and bp+6 and the swapflag can be accessed at bp-2. The subtraction in SP was after taking the snapshot; therefore BP is above the parameters but below the local variables. The parameters are therefore accessed using positive offsets from BP and the local variables are accessed using negative offsets.

We modify the bubble sort subroutine to use a local variable to store the swap flag. The swap flag remembered whether a swap has been done in a particular iteration of bubble sort.

Example 5.6	
01	; bubble sort subroutine using a local variable
02	[org 0x0100]
03	jmp start
04	
05	data: dw 60, 55, 45, 50, 40, 35, 25, 30, 10, 0
06	data2: dw 328, 329, 898, 8923, 8293, 2345, 10, 877, 355, 98

```

07         dw 888, 533, 2000, 1020, 30, 200, 761, 167, 90, 5
08
09 bubblesort:  push bp           ; save old value of bp
10             mov bp, sp       ; make bp our reference point
11             sub sp, 2        ; make two byte space on stack
12             push ax          ; save old value of ax
13             push bx          ; save old value of bx
14             push cx          ; save old value of cx
15             push si          ; save old value of si
16
17             mov bx, [bp+6]    ; load start of array in bx
18             mov cx, [bp+4]    ; load count of elements in cx
19             dec cx           ; last element not compared
20             shl cx, 1        ; turn into byte count
21
22 mainloop:   mov si, 0         ; initialize array index to zero
23             mov word [bp-2], 0 ; reset swap flag to no swaps
24
25 innerloop:  mov ax, [bx+si]    ; load number in ax
26             cmp ax, [bx+si+2] ; compare with next number
27             jbe noswap       ; no swap if already in order
28
29             xchg ax, [bx+si+2] ; exchange ax with second number
30             mov [bx+si], ax    ; store second number in first
31             mov word [bp-2], 1 ; flag that a swap has been done
32
33 noswap:    add si, 2          ; advance si to next index
34             cmp si, cx        ; are we at last index
35             jne innerloop     ; if not compare next two
36
37             cmp word [bp-2], 1 ; check if a swap has been done
38             je mainloop      ; if yes make another pass
39
40             pop si           ; restore old value of si
41             pop cx           ; restore old value of cx
42             pop bx           ; restore old value of bx
43             pop ax           ; restore old value of ax
44             mov sp, bp       ; remove space created on stack
45             pop bp           ; restore old value of bp
46             ret 4            ; go back and remove two params
47
48 start:     mov ax, data       ; place start of array on stack
49             push ax          ; place element count on stack
50             mov ax, 10
51             push ax          ; call our subroutine
52             call bubblesort
53
54             mov ax, data2
55             push ax          ; place start of array on stack
56             mov ax, 20
57             push ax          ; place element count on stack
58             call bubblesort ; call our subroutine again
59
60             mov ax, 0x4c00   ; terminate program
61             int 0x21

```

11 A word gap has been created for swap flag. This is equivalent to a dummy push. The registers are pushed above this gap.

23 The swapflag is accessed with [bp-2]. The parameters are accessed in the same manner as the last examples.

44 We are removing the hole that we created. The hole is removed by restoring the value of SP that it had at the time of snapshot or at the value it had before the local variable was created. This can be replaced with “add sp, 2” however the one used in the code is preferred since it does not require to remember how much space for local variables was allocated in the start. After this operation SP points to the old value of BP from where we can proceed as usual.

We needed memory to store the swap flag. The fact that it is in the stack segment or the data segment doesn't bother us. This will just change the addressing scheme.

Computer Architecture & Assembly Language Programming	Course Code: CS401
CS401@vu.edu.pk	VU

EXERCISES

1. Replace the following valid instruction with a single instruction that has the same effect. Don't consider the effect on flags.

```

push word L1
jmp L2
L1:

```

2. Replace the following invalid instructions with a single instruction that has the same effect.

- a. pop ip
- b. mov ip, L5
- c. sub sp, 2
mov [ss:sp], ax
- d. mov ax, [ss:sp]
add sp, 2
- e. add sp, 6
mov ip, [ss:sp-6]

3. Write a recursive function to calculate the Fibonacci of a number. The number is passed as a parameter via the stack and the calculated Fibonacci number is returned in the AX register. A local variable should be used to store the return value from the first recursive call. Fibonacci function is defined as follows:

```

Fibonacci(0) = 0
Fibonacci(1) = 1
Fibonacci(n) = Fibonacci(n-1) + Fibonacci(n-2)

```

4. Write the above Fibonacci function iteratively.
HINT: Use two registers to hold the current and the previous Fibonacci numbers in a loop.
5. Write a function `switch_stack` meant to change the current stack and will be called as below. The function should destroy no registers.

```

push word [new_stack_segment]
push word [new_stack_offset]
call switch_stack

```

6. Write a function "addtoiset" that takes offset of a function and remembers this offset in an array that can hold a maximum of 8 offsets. It does nothing if there are already eight offsets in the set. Write another function "callset" that makes a call to all functions in the set one by one.
7. Do the above exercise such that "callset" does not use a CALL or a JMP to invoke the functions.
HINT: Setup the stack appropriately such that the RET will execute the first function, its RET execute the next and so on till the last RET returns to the caller of "callset."
8. Make an array of 0x80 bytes and treat it as one of 0x400 bits. Write a function `myalloc` that takes one argument, the number of bits. It finds that many consecutive zero bits in the array, makes them one, and returns in AX the index of the first bit. Write another function `myfree` that takes two arguments, index of a bit in the array, and the number of bits. It makes that many consecutive bits zero, whatever their previous values are, starting from the index in the first argument.
9. [Circular Queue] Write functions to implement circular queues. Declare 16x32 words of data for 16 queues numbered from 0 to 15. Each queue has a front index, a rear index and 30 locations for data totaling to 32 words. Declare another word variable whose 16 bits correspond to the 16 queues and a 1 bit signals that the corresponding queue is used and a 0 bit signals that it is free. Write a function "qcreate" that returns a queue number after finding a free queue or -1 if it failed. Write a function "qdestroy" that marks the queue as free. Write two other functions "qadd" and "qremove" that

Computer Architecture & Assembly Language Programming	Course Code: CS401
CS401@vu.edu.pk	VU

can add and remove items from the circular queue. The two functions return 0 if they failed and 1 otherwise.

10. [Linked List] Declare 1024 nodes of four bytes each. The first 2 bytes will be used for data and the next 2 bytes for storing the offset of another node. Also declare a word variable "firstfree" to store the offset of the first free node. Write the following five functions:
 - a. "init" chains all 1024 nodes into a list with offset of first node in firstfree, offset of the second node in the later two bytes of the first node and so on. The later two bytes of the last node contains zero.
 - b. "createlist" returns the offset of the node stored in firstfree through AX. It sets firstfree to the offset stored in the later two bytes of that node, and it sets the later two bytes of that node to zero.
 - c. "insertafter" takes two parameters, the offset of a node and a word data. It removes one node from freelist just like "createlist" and inserts it after the said node and updates the new node's data part.
 - d. "deleteafter" takes a node as its parameter and removes the node immediately after it in the linked list if there is one.
 - e. "deletelist" takes a node as its parameters and traverses the linked list starting at this node and removes all nodes from it and add them back to the free list.

Display Memory

The debugger gives a very close vision of the processor. That is why every program written till now was executed inside the debugger. Also the debugger is a very useful tool in assembly language program development, since many bugs only become visible when each instruction is independently monitored the way the debugger allows us to do. We will now be using the display screen in character mode, the way DOS uses this screen. The way we will access this screen is specific to the IBM PC.

6.1. ASCII CODES

The computer listens, sees, and speaks in numbers. Even a character is a number inside the computer. For example the keyboard is labeled with characters however when we press 'A', a specific number is transferred from the keyboard to the computer. Our program interprets that number as the character 'A'. When the same number comes on display, the Video Graphics Adapter (VGA) in our computer shows the shape of 'A'. Even the shape is stored in binary numbers with a one bit representing a pixel on the screen that is turned on and a zero bit representing a pixel that is not glowing. This example is considering a white on black display and no colors. This is the way a shape is drawn on the screen. The interpretation of 'A' is performed by the VGA card, while the monitor or CRT (cathode ray tube) only glows the pixels on and turns them off. The keyboard has a key labeled 'A' and pressing it the screen shows 'A' but all that happened inside was in numbers.

An 'A' on any computer and any operating system is an 'A' on every other computer and operating system. This is because a standard numeric representation of all commonly used characters has been developed. This is called the ASCII code, where ASCII stands for American Standard Code for Information Interchange. The name depicts that this is a code that allows the interchange of information; 'A' written on one computer will remain an 'A' on another. The ASCII table lists all defined characters and symbols and their standardized numbers. All ASCII based computers use the same code. There are few other standards like EBCDIC and gray codes, but ASCII has become the most prevalent standard and is used for Internet communication as well. It has become the de facto standard for global communication. The character mode displays of our computer use the ASCII standard. Some newer operating systems use a new standard Unicode but it is not relevant to us in the current discussion.

Standard ASCII has 128 characters with assigned numbers from 0 to 127. When IBM PC was introduced, they extended the standard ASCII and defined 128 more characters. Thus extending the total number of symbols from 128 to 256 numbered from 0 to 255 fitting in an 8-bit byte. The newer characters were used for line drawing, window corners, and some non-English characters. The need for these characters was never felt on teletype terminals, but with the advent of IBM PC and its full screen display, these semi-graphics characters were the need of the day. Keep in mind that at that time there was no graphics mode available.

The extended ASCII code is just a de facto industry standard but it is not defined by an organization like the standard ASCII. Printers, displays, and all other peripherals related to the IBM PC understand the ASCII code. If the

Computer Architecture & Assembly Language Programming	Course Code: CS401
CS401@vu.edu.pk	VU

code for 'A' is sent to the printer, the printer will print the shape of 'A', if it is sent to the display, the VGA card will form the shape of 'A' on the CRT. If it is sent to another computer via the serial port, the other computer will understand that this is an 'A'.

The important thing to observe in the ASCII table is the contiguous arrangement of the uppercase alphabets (41-5A), the lowercase alphabets (61-7A), and the numbers (30-39). This helps in certain operations with ASCII, for example converting the case of characters by adding or subtracting 0x20 from it. It also helps in converting a digit into its ASCII representation by adding 0x30 to it.

6.2. DISPLAY MEMORY FORMATION

We will explore the working of the display with ASCII codes, since it is our immediately accessible hardware. When 0x40 is sent to the VGA card, it will turn pixels on and off in such a way that a visual representation of 'A' appears on the screen. It has no reality, just an interpretation. In later chapters we will program the VGA controller to display a new shape when the ASCII of 'A' is received by it.

The video device is seen by the computer as a memory area containing the ASCII codes that are currently displayed on the screen and a set of I/O ports controlling things like the resolution, the cursor height, and the cursor position. The VGA memory is seen by the computer just like its own memory. There is no difference; rather the computer doesn't differentiate, as it is accessible on the same bus as the system memory. Therefore if that appropriate block of the screen is cleared, the screen will be cleared. If the ASCII of 'A' is placed somewhere in that block, the shape of 'A' will appear on the screen at a corresponding place.

This correspondence must be defined as the memory is a single dimensional space while the screen is two dimensional having 80 rows and 25 columns. The memory is linearly mapped on this two dimensional space, just like a two dimensional is mapped in linear memory. There is one word per character in which a byte is needed for the ASCII code and the other byte is used for the character's attributes discussed later. Now the first 80 words will correspond to the first row of the screen and the next 80 words will correspond to the next row. By making the memory on the video controller accessible to the processor via the system bus, the processor is now in control of what is displayed on the screen.

The three important things that we discussed are.

- One screen location corresponds to a word in the video memory
- The video controller memory is accessible to the processor like its own memory.
- ASCII code of a character placed at a cell in the VGA memory will cause the corresponding ASCII shape to be displayed on the corresponding screen location.

Display Memory Base Address

The memory at which the video controller's memory is mapped must be a standard, so that the program can be written in a video card independent manner. Otherwise if different vendors map their video memory at different places in the address space, as was the problem in the start, writing software was a headache. BIOS vendors had a problem of dealing with various card vendors. The IBM PC text mode color display is now fixed so that system software can work uniformly. It was fixed at the physical memory location of B8000. The first byte at this location contains the ASCII for the character displayed at the top left of the video screen. Dropping the zero we can load the rest in a segment register to access the video memory. If we do something in this memory, the effect can be seen on the screen. For example we can

write a virus that makes any character we write drop to the bottom of the screen.

Attribute Byte

The second byte in the word designated for one screen location holds the foreground and background colors for the character. This is called its video attribute. So the pair of the ASCII code in one byte and the attribute in the second byte makes the word that corresponds to one location on the screen. The lower address contains the code while the higher one contains the attribute. The attribute byte as detailed below has the RGB for the foreground and the background. It has an intensity bit for the foreground color as well thus making 16 possible colors of the foreground and 8 possible colors for the background. When bit 7 is set the character keeps on blinking on the screen. This bit has some more interpretations like background intensity that has to be activated in the video controller through its I/O ports.

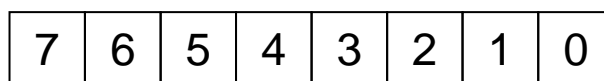

- 7 – Blinking of foreground character
- 6 – Red component of background color
- 5 – Green component of background color
- 4 – Blue component of background color
- 3 – Intensity component of foreground color
- 2 – Red component of foreground color
- 1 – Green component of foreground color
- 0 – Blue component of foreground color

Display Examples

Both DS and ES can be used to access the video memory. However we commonly keep DS for accessing our data, and load ES with the segment of video memory. Loading a segment register with an immediate operand is not allowed in the 8088 architecture. We therefore load the segment register via a general purpose register. Other methods are loading from a memory location and a combination of push and pop.

```
mov ax, 0xb800
mov es, ax
```

This operation has opened a window to the video memory. Now the following instruction will print an 'A' on the top left of the screen in white color on black background.

```
mov word [es:0], 0x0741
```

The segment override is used since ES is pointing to the video memory. Since the first word is written to, the character will appear at the top left of the screen. The 41 that goes in the lower byte is the ASCII code for 'A'. The 07 that goes in the higher byte is the attribute with I=0, R=1, G=1, B=1 for the foreground, meaning white color in low intensity and R=0, G=0, B=0 for the background meaning black color and the most significant bit cleared so that there is no blinking. Now consider the following instruction.

```
mov word [es:160], 0x1230
```

This is displayed 80 words after the start and there are 80 characters in one screen row. Therefore this is displayed on the first column of the second line. The ASCII code used is 30, which represents a '0' while the attribute byte is 12 meaning green color on black background.

We take our first example to clear the screen.

Example 6.1

01 02 03 04 05 06 07 08 09 10 11 12 13	<pre> ; clear the screen [org 0x0100] mov ax, 0xb800 ; load video base in ax mov es, ax ; point es to video base mov di, 0 ; point di to top left column nextchar: mov word [es:di], 0x0720 ; clear next char on screen add di, 2 ; move to next screen location cmp di, 4000 ; has the whole screen cleared jne nextchar ; if no clear next position mov ax, 0x4c00 ; terminate program int 0x21 </pre>
07 08 09	<p>The code for space is 20 while 07 is the normal attribute of low intensity white on black with no blinking. Even to clear the screen or put a blank on a location there is a numeric code.</p> <p>DI is incremented twice since each screen location corresponds to two byte in video memory.</p> <p>DI is compared with $80*25*2=4000$. The last word location that corresponds to the screen is 3998.</p>

Inside the debugger the operation of clearing the screen cannot be observed since the debugger overwrites whatever is displayed on the screen. Directly executing the COM file from the command prompt*, we can see that the screen is cleared. The command prompt that reappeared is printed after the termination of our application. This is the first application that can be directly executed to see some output on the screen.

6.3. HELLO WORLD IN ASSEMBLY LANGUAGE

To declare a character in assembly language, we store its ASCII code in a byte. The assembler provides us with another syntax that doesn't force us to remember the ASCII code. The assembler also provides a syntax that simplifies declaration of consecutive characters, usually called a string. The three ways used below are identical in their meaning.

```

db 0x61, 0x61, 0x63
db 'a', 'b', 'c'
db 'abc'

```

When characters are stored in any high level or low level language the actual thing stored in a byte is their ASCII code. The only thing the language helps in is a simplified declaration.

Traditionally the first program in higher level languages is to print "hello world" on the screen. However due to the highly granular nature of assembly language, we are only now able to write it in assembly language. In writing this program, we make a generic routine that can print any string on the screen.

Example 6.2	
01 02 03 04 05 06 07 08 09 10 11	<pre> ; hello world in assembly [org 0x0100] jmp start message: db 'hello world' ; string to be printed length: dw 11 ; length of the string ; subroutine to clear the screen clrscr: push es push ax push di </pre>

* Remember that if this example is run in a DOS window on some newer operating systems, a full screen DOS application must be run before this program so that screen access is enabled.

```

12
13         mov ax, 0xb800
14         mov es, ax           ; point es to video base
15         mov di, 0           ; point di to top left column
16
17 nextloc:  mov word [es:di], 0x0720 ; clear next char on screen
18         add di, 2           ; move to next screen location
19         cmp di, 4000        ; has the whole screen cleared
20         jne nextloc        ; if no clear next position
21
22         pop di
23         pop ax
24         pop es
25         ret
26
27 ; subroutine to print a string at top left of screen
28 ; takes address of string and its length as parameters
29 printstr: push bp
30         mov bp, sp
31         push es
32         push ax
33         push cx
34         push si
35         push di
36
37         mov ax, 0xb800
38         mov es, ax           ; point es to video base
39         mov di, 0           ; point di to top left column
40         mov si, [bp+6]      ; point si to string
41         mov cx, [bp+4]      ; load length of string in cx
42         mov ah, 0x07        ; normal attribute fixed in al
43
44 nextchar: mov al, [si]      ; load next char of string
45         mov [es:di], ax    ; show this char on screen
46         add di, 2           ; move to next screen location
47         add si, 1           ; move to next char in string
48         loop nextchar      ; repeat the operation cx times
49
50         pop di
51         pop si
52         pop cx
53         pop ax
54         pop es
55         pop bp
56         ret 4
57
58 start:   call clrscr        ; call the clrscr subroutine
59
60         mov ax, message
61         push ax             ; push address of message
62         push word [length] ; push message length
63         call printstr      ; call the printstr subroutine
64
65         mov ax, 0x4c00     ; terminate program
66         int 0x21

```

05-06 The string definition syntax discussed above is used to declare a string “hello world” of 11 bytes and the length is stored in a separate variable.

09-25 The code to clear the screen from the last example is written in the form of a subroutine. Since the subroutine had no parameters, only modified registers are saved and restored from the stack.

29-35 The standard subroutine format with parameters received via stack and all registers saved and restored is used.

37-42 ES is initialized to point to the video memory via the AX register. Two pointer registers are used; SI to point to the string and DI to point to the top left location of the screen. CX is loaded with the length of the string. Normal attribute of low intensity white on black with no blinking is loaded in the AH register.

44-45 The next character from the string is loaded into AL. Now AH holds the attribute and AL the ASCII code of the character. This pair is

46-47	written on the video memory using DI with the segment override prefix for ES to access the video memory segment.
48	The string pointer is incremented by one while the video memory pointer is incremented by two since one char corresponds to a word on the screen.
50-56	The loop instruction used is equivalent to a combination of “dec cx” and “jnz nextchar.” The loop is executed CX times.
62	The registers pushed on the stack are recovered in opposite order and the “ret 4” instruction removes the two parameters placed on the stack. Memory can be directly pushed on the stack.

When the program is executed, screen is cleared and the greetings is displayed on the top left of the screen. This screen location and the attribute used were hard coded in the program and can also be made variable. Then we will be able to print anywhere on the screen.

6.4. NUMBER PRINTING IN ASSEMBLY

Another problem related to the display is printing numbers. Every high level language allows some simple way to print numbers on the screen. As we have seen, everything on the screen is a pair of ASCII code and its attribute and a number is a raw binary number and not a collection of ASCII codes. For example a 10 is stored as a 10 and not as the ASCII code of 1 followed by the ASCII code of 0. If this 10 is stored in a screen location, the output will be meaningless, as the character associate to ASCII code 10 will be shown on the screen. So there is a process that converts a number in its ASCII representation. This process works for any number in any base. We will discuss our examples with respect to the decimal base and later observe the effect of changing to different bases.

Number Printing Algorithm

The key idea is to divide the number by the base number, 10 in the case of decimal. The remainder can be from 0-9 and is the right most digit of the original number. The remaining digits fall in the quotient. The remainder can be easily converted into its ASCII equivalent and printed on the screen. The other digits can be printed in a similar manner by dividing the quotient again by 10 to separate the next digit and so on.

However the problem with this approach is that the first digit printed is the right most one. For example 253 will be printed as 352. The remainder after first division was 3, after second division was 5 and after the third division was 2. We have to somehow correct the order so that the actual number 253 is displayed, and the trick is to use the stack since the stack is a Last In First Out structure so if 3, 5, and 2 are pushed on it, 2, 5, and 3 will come out in this order. The steps of our algorithm are outlined below.

- Divide the number by base (10 in case of decimal)
- The remainder is its right most digit
- Convert the digit to its ASCII representation (Add 0x30 to the remainder in case of decimal)
- Save this digit on stack
- If the quotient is non-zero repeat the whole process to get the next digit, otherwise stop
- Pop digits one by one and print on screen left to right

DIV Instruction

The division used in the process is integer division and not floating point division. Integer division gives an integer quotient and an integer remainder. A division algorithm is now needed. Fortunately or unfortunately there is a

DIV instruction available in the 8088 processor. There are two forms of the DIV instruction. The first form divides a 32bit number in DX:AX by its 16bit operand and stores the 16bit quotient in AX and the 16bit remainder in DX. The second form divides a 16bit number in AX by its 8bit operand and stores the 8bit quotient in AL and the 8bit remainder in AH. For example “DIV BL” has an 8bit operand, so the implied dividend is 16bit and is stored in the AX register and “DIV BX” has a 16bit operand, so the implied dividend is 32bit and is therefore stored in the concatenation of the DX and AX registers. The higher word is stored in DX and the lower word in AX.

If a large number is divided by a very small number it is possible that the quotient is larger than the space provided for it in the implied destination. In this case an interrupt is automatically generated and the program is usually terminated as a result. This is called a divide overflow error; just like the calculator shows an -E- when the result cannot be displayed. This interrupt will be discussed later in the discussion of interrupts.

DIV (divide) performs an unsigned division of the accumulator (and its extension) by the source operand. If the source operand is a byte, it is divided into the two-byte dividend assumed to be in registers AL and AH. The byte quotient is returned in AL, and the byte remainder is returned in AH. If the source operand is a word, it is divided into the two-word dividend in registers AX and DX. The word quotient is returned in AX, and the word remainder is returned in DX. If the quotient exceeds the capacity of its destination register (FF for byte source, FFFF for word source), as when division by zero is attempted, a type 0 interrupt is generated, and the quotient and remainder are undefined.

Number Printing Example

The next example introduces a subroutine that can print a number received as its only argument at the top left of the screen using the algorithm just discussed.

Example 6.3	
001	; number printing algorithm
002	[org 0x0100]
003	jmp start
004	
005-022	;;;; COPY LINES 008-025 FROM EXAMPLE 6.2 (clrscr) ;;;;;
023	
024	; subroutine to print a number at top left of screen
025	; takes the number to be printed as its parameter
026	printnum: push bp
027	mov bp, sp
028	push es
029	push ax
030	push bx
031	push cx
032	push dx
033	push di
034	
035	mov ax, 0xb800
036	mov es, ax ; point es to video base
037	mov ax, [bp+4] ; load number in ax
038	mov bx, 10 ; use base 10 for division
039	mov cx, 0 ; initialize count of digits
040	
041	nextdigit: mov dx, 0 ; zero upper half of dividend
042	div bx ; divide by 10
043	add dl, 0x30 ; convert digit into ascii value
044	push dx ; save ascii value on stack
045	inc cx ; increment count of values
046	cmp ax, 0 ; is the quotient zero
047	jnz nextdigit ; if no divide it again
048	
049	mov di, 0 ; point di to top left column
050	

```

051      nextpos:      pop dx                ; remove a digit from the stack
052                mov dh, 0x07           ; use normal attribute
053                mov [es:di], dx        ; print char on screen
054                add di, 2              ; move to next screen location
055                loop nextpos           ; repeat for all digits on stack
056
057                pop di
058                pop dx
059                pop cx
060                pop bx
061                pop ax
062                pop es
063                pop bp
064                ret 2
065
066      start:       call clrscr           ; call the clrscr subroutine
067
068                mov ax, 4529
069                push ax                 ; place number on stack
070                call printnum          ; call the printnum subroutine
071
072                mov ax, 0x4c00         ; terminate program
073                int 0x21

```

026-033	The registers are saved as an essential practice. The only parameter received is the number to be printed.
035-039	ES is initialized to video memory. AX holds the number to be printed. BX is the desired base, and can be loaded from a parameter. CX holds the number of digits pushed on the stack. This count is initialized to zero, incremented with every digit pushed and is used when the digits are popped one by one.
041-042	DX must be zeroed as our dividend is in AX and we want a 32bit division. After the division AX holds the quotient and DX holds the remainder. Actually the remainder is only in DL since the remainder can be from 0 to 9.
043-045	The remainder is converted into its ASCII representation and saved on the stack. The count of digits on the stack is incremented as well.
046-047	If the quotient is zero, all digits have been saved on the stack and if it is non-zero, we have to repeat the process to print the next digit.
049	DI is initialized to point to the top left of the screen, called the cursor home. If the screen location is to become a parameter, the value loaded in DI will change.
051-053	A digit is popped off the stack, the attribute byte is appended to it and it is displayed on the screen.
054-055	The next screen location is two bytes ahead so DI is incremented by two. The process is repeated CX times which holds the number of digits pushed on the stack.
057-064	We pop the registers pushed and “ret 2” to discard the only parameter on the stack.
066-070	The main program clears the screen and calls the printnum subroutine to print 4529 on the top left of the screen.

When the program is executed 4529 is printed on the top left of the screen. This algorithm is versatile in that the base number can be changed and the printing will be in the desired base. For example if “mov bx, 10” is changed to “mov bx, 2” the output will be in binary as 001000110110001. Similarly changing it to “mov bx, 8” outputs the number in octal as 10661. Printing it in hexadecimal is a bit tricky, as the ASCII codes for A-F do not consecutively start after the codes for 0-9. Inside the debugger observe the working of the algorithm is just as described in the above illustration. The digits are

separated one by one and saved on the stack. From bottom to top, the stack holds 0034, 0035, 0032, and 0039 after the first loop is completed. The next loop pops them one by one and routes them to the screen.

6.5. SCREEN LOCATION CALCULATION

Until now our algorithms used a fixed attribute and displayed at a fixed screen location. We will change that to use any position on the screen and any attribute. For mapping from the two dimensional coordinate system of the screen to the one dimensional memory, we need to multiply the row number by 80 since there are 80 columns per row and add the column number to it and again multiply by two since there are 2 bytes for each character.

For this purpose the multiplication routine written previously can be used. However we introduce an instruction of the 8088 microprocessor at this time that can multiply 8bit or 16bit numbers.

MUL Instruction

MUL (multiply) performs an unsigned multiplication of the source operand and the accumulator. If the source operand is a byte, then it is multiplied by register AL and the double-length result is returned in AH and AL. If the source operand is a word, then it is multiplied by register AX, and the double-length result is returned in registers DX and AX.

String Printing at Desired Location

We modify the string printing program to take the x-position, the y-position, and the attribute as parameters. The desired location on the screen can be calculated with the following formulae.

$$\text{location} = (\text{hypos} * 80 + \text{epos}) * 2$$

Example 6.4

```

01      ; hello world at desired screen location
02      [org 0x0100]
03              jmp  start
04
05      message:  db  'hello world'      ; string to be printed
06      length:   dw  11                  ; length of the string
07
08-25   ;;;; COPY LINES 008-025 FROM EXAMPLE 6.2 (clrscr) ;;;;
26
27      ; subroutine to print a string at top left of screen
28      ; takes x position, y position, string attribute, address of string
29      ; and its length as parameters
30      printstr:  push bp
31                  mov  bp, sp
32                  push es
33                  push ax
34                  push cx
35                  push si
36                  push di
37
38                  mov  ax, 0xb800
39                  mov  es, ax            ; point es to video base
40                  mov  al, 80            ; load al with columns per row
41                  mull  byte [bp+10]     ; multiply with y position
42                  add  ax, [bp+12]      ; add x position
43                  shl  ax, 1            ; turn into byte offset
44                  mov  di, ax           ; point di to required location
45                  mov  si, [bp+6]       ; point si to string
46                  mov  cx, [bp+4]       ; load length of string in cx
47                  mov  ah, [bp+8]       ; load attribute in ah
48
49      nextchar:  mov  al, [si]           ; load next char of string
50                  mov  [es:di], ax      ; show this char on screen
51                  add  di, 2            ; move to next screen location

```

```

52         add si, 1           ; move to next char in string
53         loop nextchar      ; repeat the operation cx times
54
55         pop di
56         pop si
57         pop cx
58         pop ax
59         pop es
60         pop bp
61         ret 10
62
63 start:   call clrscr        ; call the clrscr subroutine
64
65         mov ax, 30
66         push ax            ; push x position
67         mov ax, 20
68         push ax            ; push y position
69         mov ax, 1          ; blue on black attribute
70         push ax            ; push attribute
71         mov ax, message
72         push ax            ; push address of message
73         push word [length] ; push message length
74         call printstr      ; call the printstr subroutine
75
76         mov ax, 0x4c00     ; terminate program
77         int 0x21

```

41	Push and pop operations always operate on words; however data can be read as a word or as a byte. For example we read the lower byte of the parameter y-position in this case.
43	Shifting is used for multiplication by two, which should always be the case when multiplication or division by a power of two is desired.
61	The subroutine had 5 parameters so “ret 10” is used.
65-74	The main program pushes 30 as x-position, 20 as y-position meaning 30th column on 20th row. It pushes 1 as the attribute meaning low intensity blue on black with no blinking.

When the program is executed hello world is displayed at the desired screen location in the desired color. The x-position, y-position, and attribute parameters can be changed and their effect be seen on the screen. The important difference in this example is the use of MUL instruction and the calculation of screen location given the x and y positions.

EXERCISES

1. Replace the following valid instruction with a single instruction that has the same effect. Don't consider the effect on flags.

```

dec cx
jnz L3

```
2. Write an infinite loop that shows two asterisks moving from right and left centers of the screen to the middle and then back. Use two empty nested loops with large counters to introduce some delay so that the movement is noticeable.
3. Write a function “printaddr” that takes two parameters, the segment and offset parts of an address, via the stack. The function should print the physical address corresponding to the segment offset pair passed at the top left of the screen. The address should be printed in hex and will therefore occupy exactly five columns. For example, passing 5600 and 7800 as parameters should result in 5D800 printed at the top left of the screen.
4. Write code that treats an array of 500 bytes as one of 4000 bits and for each blank position on the screen (i.e. space) sets the corresponding bit to zero and the rest to one.

Computer Architecture & Assembly Language Programming	Course Code: CS401
CS401@vu.edu.pk	VU

5. Write a function “drawrect” that takes four parameters via the stack. The parameters are top, left, bottom, and right in this order. The function should display a rectangle on the screen using the characters + - and |.

String Instructions

7.1. STRING PROCESSING

Till now very simple instructions of the 8088 microprocessor have been introduced. In this chapter we will discuss a bit more powerful instructions that can process blocks of data in one go. They are called block processing or string instructions. This is the appropriate place to discuss these instructions as we have just introduced a block of memory, which is the video memory. The vision of this memory for the processor is just a block of memory starting at a special address. For example the clear screen operation initializes this whole block to 0741.

There are just 5 block processing instructions in 8088. In the primitive form, the instructions themselves operate on a single cell of memory at one time. However a special prefix repeats the instruction in hardware called the REP prefix. The REP prefix allows these instructions to operate on a number of data elements in one instruction. This is not like a loop; rather this repetition is hard coded in the processor. The five instructions are STOS, LODS, CMPS, SCAS, and MOVS called store string, load string, compare string, scan string, and move string respectively. MOVS is the instruction that allows memory to memory moves, as was discussed in the exceptions to the memory to memory movement rules. String instructions are complex instruction in that they perform a number of tasks against one instruction. And with the REP prefix they perform the task of a complex loop in one instruction. This causes drastic speed improvements in operations on large blocks of memory. The reduction in code size and the improvement in speed are the two reasons why these instructions were introduced in the 8088 processor.

There are a number of common things in these instructions. Firstly they all work on a block of data. DI and SI are used to access memory. SI and DI are called source index and destination index because of string instructions. Whenever an instruction needs a memory source, DS:SI holds the pointer to it. An override is possible that can change the association from DS but the default is DS. Whenever a string instruction needs a memory destination, ES:DI holds the pointer to it. No override is possible in this case. Whenever a byte register is needed, AL holds the value. Whenever a word register is used AX holds the value. For example STOS stores a register in memory so AL or AX is the register used and ES:DI points to the destination. The LODS instruction loads from memory to register so the source is pointed to by DS:SI and the register used is AL or AX.

String instructions work on a block of data. A block has a start and an end. The instructions can work from the start towards the end and from the end towards the start. In fact they can work in both directions, and they must be allowed to work in both directions otherwise certain operations with overlapping blocks become impossible. This problem is discussed in detail later. The direction of movement is controlled with the Direction Flag (DF) in the flags register. If this flag is cleared the direction is from lower addresses towards higher addresses and if this flag is set the direction is from higher addresses to lower addresses. If DF is cleared, this is called the auto-increment mode of string instruction, and if DF is set, this is called the auto-decrement mode. There are two instructions to set and clear the direction flag.

Computer Architecture & Assembly Language Programming	Course Code: CS401
CS401@vu.edu.pk	VU

```
cld      ; clear direction flag
std      ; set direction flag
```

Every string instruction has two variants; a byte variant and a word variant. For example the two variants of STOS are STOSB and STOSW. Similarly the variants for the other string instructions are attained by appending a B or a W to the instruction name. The operation of each of the string instructions and each of the repetition prefixes is discussed below.

STOS

STOS transfers a byte or word from register AL or AX to the string element addressed by ES:DI and updates DI to point to the next location. STOS is often used to clear a block of memory or fill it with a constant.

The implied source will always be in AL or AX. If DF is clear, SI will be incremented by one or two depending of whether STOSB or STOSW is used. If DF is set SI will be decremented by one or two depending of whether STOSB or STOSW is used. If REP is used before this instruction, the process will be repeated CX times. CX is called the counter register because of the special treatment given to it in the LOOP and JCXZ instructions and the REP set of prefixes. So if REP is used with STOS the whole block of memory will be filled with a constant value. REP will always decrement CX like the LOOP instruction and this cannot be changed with the direction flag. It is also independent of whether the byte or the word variant is used. It always decrements by one; therefore CX has count of repetitions and not the count of bytes.

LODS

LODS transfers a byte or word from the source location DS:SI to AL or AX and updates SI to point to the next location. LODS is generally used in a loop and not with the REP prefix since the value previously loaded in the register is overwritten if the instruction is repeated and only the last value of the block remains in the register.

SCAS

SCAS compares a source byte or word in register AL or AX with the destination string element addressed by ES:DI and updates the flags. DI is updated to point to the next location. SCAS is often used to locate equality or in-equality in a string through the use of an appropriate prefix.

SCAS is a bit different from the other instructions. This is more like the CMP instruction in that it does subtraction of its operands. The prefixes REPE (repeat while equal) and REPNE (repeat while not equal) are used with this instruction. The instruction is used to locate a byte in AL in the block of memory. When the first equality or inequality is encountered; both have uses. For example this instruction can be used to search for a 0 in a null terminated string to calculate the length of the string. In this form REPNE will be used to repeat while the null is not there.

MOVS

MOVS transfers a byte or word from the source location DS:SI to the destination ES:DI and updates SI and DI to point to the next locations. MOVS is used to move a block of memory. The DF is important in the case of overlapping blocks. For example when the source and destination blocks overlap and the source is below the destination copy must be done upwards while if the destination is below the source copy must be done downwards. We cannot perform both these copy operations properly if the direction flag was not provided. If the source is below the destination and an upwards copy is used the source to be copied is destroyed. If however the copy is done downwards the portion of source destroyed is the one that has already been

copied. Therefore we need the control of the direction flag to handle this problem. This problem is further detailed in a later example.

CMPS

CMPS subtracts the source location DS:SI from the destination location ES:DI. Source and Destination are unaffected. SI and DI are updated accordingly. CMPS compares two blocks of memory for equality or inequality of the block. It subtracts byte by byte or word by word. If used with a REPE or a REPNE prefix it repeats as long as the blocks are same or as long as they are different. For example it can be used for find a substring. A substring is a string that is contained in another string. For example “has” is contained in “Mary has a little lamp.” Using CMPS we can do the operation of a complex loop in a single instruction. Only the REPE and REPNE prefixes are meaningful with this instruction.

REP Prefix

REP repeats the following string instruction CX times. The use of CX is implied with the REP prefix. The decrement in CX doesn’t affect any flags and the jump is also independent of the flags, just like JCXZ.

REPE and REPNE Prefixes

REPE or REPZ repeat the following string instruction while the zero flag is set and REPNE or REPNZ repeat the following instruction while the zero flag is not set. REPE or REPNE are used with the SCAS or CMPS instructions. The other string instructions have nothing to do with the condition since they are performing no comparison. Also the initial state of flags before the string instruction does not affect the operation. The most complex operation of the string instruction is with these prefixes.

7.2. STOS EXAMPLE – CLEARING THE SCREEN

We take the example of clearing the screen and observe that how simple and fast this operation is with the string instructions. Even if there are three instructions in a loop they have to be fetched and decoded with every iteration and the time of three instructions is multiplied by the number of iterations of the loop. In the case of string instructions, many operations are short circuited. The instruction is fetched and decoded once and only the execution is repeated CX times. That is why string instructions are so efficient in their operation. The program to clear the screen places 0720 on the 2000 words on the screen.

Example 7.1	
001	; clear screen using string instructions
002	[org 0x0100]
003	jmp start
004	
005	; subroutine to clear the screen
006	clrscr: push es
007	push ax
008	push cx
009	push di
010	
011	mov ax, 0xb800
012	mov es, ax ; point es to video base
013	xor di, di ; point di to top left column
014	mov ax, 0x0720 ; space char in normal attribute
015	mov cx, 2000 ; number of screen locations
016	
017	cld ; auto increment mode
018	rep stosw ; clear the whole screen
019	
020	pop di

021	pop cx	
022	pop ax	
023	pop es	
024	ret	
025		
026	start: call clrscr	; call clrscr subroutine
027		
028	mov ax, 0x4c00	; terminate program
029	int 0x21	
013	A space efficient way to zero a 16bit register is to XOR it with itself. Remember that exclusive or results in a zero whenever the bits at the source and at the destination are same. This instruction takes just two bytes compared to “mov di, 0” which would take three. This is a standard way to zero a 16bit register.	

Inside the debugger the operation of the string instruction can be monitored. The trace into command can be used to monitor every repetition of the string instruction. However screen will not be cleared inside the debugger as the debugger overwrites its display on the screen so CX decrements with every iteration, DI increments by 2. The first access is made at B800:0000 and the second at B800:0002 and so on. A complex and inefficient loop is replaced with a fast and simple instruction that does the same operation many times faster.

7.3. LODS EXAMPLE – STRING PRINTING

The use of LODS with the REP prefix is not meaningful as only the last value loaded will remain in the register. It is normally used in a loop paired with a STOS instruction to do some block processing. We use LODS to pick the data, do the processing, and then use STOS to put it back or at some other place. For example in string printing, we will use LODS to read a character of the string, attach the attribute byte to it, and use STOS to write it on the video memory.

The following example will print the string using string instructions.

Example 7.2		
001	; hello world printing using string instructions	
002	[org 0x0100]	
003	jmp	start
004		
005	message:	db 'hello world' ; string to be printed
006	length:	dw 11 ; length of string
007		
008-027	;;;; COPY LINES 005-024 FROM EXAMPLE 7.1 (clrscr) ;;;;	
028		
029	; subroutine to print a string	
030	; takes the x position, y position, attribute, address of string and	
031	; its length as parameters	
032	printstr:	push bp
033		mov bp, sp
034		push es
035		push ax
036		push cx
037		push si
038		push di
039		
040	mov	ax, 0xb800
041	mov	es, ax ; point es to video base
042	mov	al, 80 ; load al with columns per row
043	mul	byte [bp+10] ; multiply with y position
044	add	ax, [bp+12] ; add x position
045	shl	ax, 1 ; turn into byte offset
046	mov	di, ax ; point di to required location
047	mov	si, [bp+6] ; point si to string
048	mov	cx, [bp+4] ; load length of string in cx
049	mov	ah, [bp+8] ; load attribute in ah

```

050
051         cld                ; auto increment mode
052 nextchar: lodsb           ; load next char in al
053         stosw             ; print char/attribute pair
054         loop nextchar    ; repeat for the whole string
055
056         pop di
057         pop si
058         pop cx
059         pop ax
060         pop es
061         pop bp
062         ret 10
063
064 start:   call clrscr      ; call the clrscr subroutine
065
066         mov ax, 30
067         push ax          ; push x position
068         mov ax, 20
069         push ax          ; push y position
070         mov ax, 1        ; blue on black attribute
071         push ax          ; push attribute
072         mov ax, message
073         push ax          ; push address of message
074         push word [length] ; push message length
075         call printstr    ; call the printstr subroutine
076
077         mov ax, 0x4c00   ; terminate program
078         int 0x21

```

051 Both operations are in auto increment mode.

052-053 DS is automatically initialized to our segment. ES points to video memory. SI points to the address of our string. DI points to the screen location. AH holds the attribute. Whenever we read a character from the string in AL, the attribute byte is implicitly attached and the pair is present in AX. The same effect could not be achieved with a REP prefix as the REP will repeat LODS and then start repeating STOS, but we need to alternate them.

054 CX holds the length of the string. Therefore LOOP repeats for each character of the string.

Inside the debugger we observe how LODS and STOS alternate and CX is only used by the LOOP instruction. In the original code there were four instructions inside the loop; now there are only two. This is how string instructions help in reducing code size.

7.4. SCAS EXAMPLE – STRING LENGTH

Many higher level languages do not explicitly store string length; rather they use a null character, a character with an ASCII code of zero, to signal the end of a string. In assembly language programs, it is also easier to store a zero at the end of the string, instead of calculating the length of string, which is very difficult process for longer strings. So we delegate length calculation to the processor and modify our string printing subroutine to take a null terminated string and no length. We use SCASB with REPNE and a zero in AL to find a zero byte in the string. In CX we load the maximum possible size, which is 64K bytes. However actual strings will be much smaller. An important thing regarding SCAS and CMPS is that if they stop due to equality or inequality, the index registers have already incremented. Therefore when SCAS will stop DI would be pointing past the null character.

Example 7.3	
001	; hello world printing with a null terminated string
002	[org 0x0100]

```

003             jmp  start
004
005  message:    db  'hello world', 0    ; null terminated string
006
007-026  ;;;; COPY LINES 005-024 FROM EXAMPLE 7.1 (clrscr) ;;;;
027
028  ; subroutine to print a string
029  ; takes the x position, y position, attribute, and address of a null
030  ; terminated string as parameters
031  printstr:   push bp
032             mov  bp, sp
033             push es
034             push ax
035             push cx
036             push si
037             push di
038
039             push ds
040             pop  es                ; load ds in es
041             mov  di, [bp+4]        ; point di to string
042             mov  cx, 0xffff        ; load maximum number in cx
043             xor  al, al            ; load a zero in al
044             repne scasb           ; find zero in the string
045             mov  ax, 0xffff        ; load maximum number in ax
046             sub  ax, cx            ; find change in cx
047             dec  ax                ; exclude null from length
048             jz   exit             ; no printing if string is empty
049
050             mov  cx, ax            ; load string length in cx
051             mov  ax, 0xb800
052             mov  es, ax            ; point es to video base
053             mov  al, 80            ; load al with columns per row
054             mul  byte [bp+8]        ; multiply with y position
055             add  ax, [bp+10]        ; add x position
056             shl  ax, 1             ; turn into byte offset
057             mov  di, ax           ; point di to required location
058             mov  si, [bp+4]        ; point si to string
059             mov  ah, [bp+6]        ; load attribute in ah
060
061             cld                    ; auto increment mode
062  nextchar:   lodsb                 ; load next char in al
063             stosw                  ; print char/attribute pair
064             loop nextchar         ; repeat for the whole string
065
066  exit:       pop  di
067             pop  si
068             pop  cx
069             pop  ax
070             pop  es
071             pop  bp
072             ret  8
073
074  start:     call clrscr            ; call the clrscr subroutine
075
076             mov  ax, 30
077             push ax                ; push x position
078             mov  ax, 20
079             push ax                ; push y position
080             mov  ax, 1              ; blue on black attribute
081             push ax                ; push attribute
082             mov  ax, message
083             push ax                ; push address of message
084             call printstr          ; call the printstr subroutine
085
086             mov  ax, 0x4c00        ; terminate program
087             int  0x21

```

039-040 Another way to load a segment register is to use a combination of push and pop. The processor doesn't match pushes and pops. ES is equalized to DS in this pair of instructions.

Inside the debugger observe the working of the code for length calculation after SCASB has completed its operation.

Computer Architecture & Assembly Language Programming	Course Code: CS401
CS401@vu.edu.pk	VU

LES and LDS Instructions

Since the string instructions need their source and destination in the form of a segment offset pair, there are two special instructions that load a segment register and a general purpose register from two consecutive memory locations. LES loads ES while LDS loads DS. Both these instructions have two parameters, one is the general purpose register to be loaded and the other is the memory location from which to load these registers. The major application of these instructions is when a subroutine receives a segment offset pair as an argument and the pair is to be loaded in a segment and an offset register. According to Intel rules of significance the word at higher address is loaded in the segment register while the word at lower address is loaded in the offset register. As parameters segment should be pushed first so that it ends up at a higher address and the offset should be pushed afterwards. When loading the lower address will be given. For example “lds si, [bp+4]” will load SI from BP+4 and DS from BP+6.

7.5. LES AND LDS EXAMPLE

We modify the string length calculation subroutine to take the segment and offset of the string and use the LES instruction to load that segment offset pair in ES and DI.

Example 7.4	
001	; hello world printing with length calculation subroutine
002	[org 0x0100]
003	jmp start
004	
005	message: db 'hello world', 0 ; null terminated string
006	
007-026	;;;;; COPY LINES 005-024 FROM EXAMPLE 7.1 (clrscr) ;;;;;
027	
028	; subroutine to calculate the length of a string
029	; takes the segment and offset of a string as parameters
030	strlen: push bp
031	mov bp,sp
032	push es
033	push cx
034	push di
035	
036	les di, [bp+4] ; point es:di to string
037	mov cx, 0xffff ; load maximum number in cx
038	xor al, al ; load a zero in al
039	repne scasb ; find zero in the string
040	mov ax, 0xffff ; load maximum number in ax
041	sub ax, cx ; find change in cx
042	dec ax ; exclude null from length
043	
044	pop di
045	pop cx
046	pop es
047	pop bp
048	ret 4
049	
050	; subroutine to print a string
051	; takes the x position, y position, attribute, and address of a null
052	; terminated string as parameters
053	printstr: push bp
054	mov bp, sp
055	push es
056	push ax
057	push cx
058	push si
059	push di
060	
061	push ds ; push segment of string
062	mov ax, [bp+4]
063	push ax ; push offset of string
064	call strlen ; calculate string length

```

065          cmp ax, 0          ; is the string empty
066          jz  exit          ; no printing if string is empty
067          mov cx, ax        ; save length in cx
068
069          mov ax, 0xb800
070          mov es, ax        ; point es to video base
071          mov al, 80        ; load al with columns per row
072          mul byte [bp+8]   ; multiply with y position
073          add ax, [bp+10]   ; add x position
074          shl ax, 1        ; turn into byte offset
075          mov di, ax        ; point di to required location
076          mov si, [bp+4]   ; point si to string
077          mov ah, [bp+6]   ; load attribute in ah
078
079          cld                ; auto increment mode
080  nextchar: lodsb           ; load next char in al
081          stosw            ; print char/attribute pair
082          loop nextchar    ; repeat for the whole string
083
084  exit:    pop di
085          pop si
086          pop cx
087          pop ax
088          pop es
089          pop bp
090          ret 8
091
092  start:   call clrscr      ; call the clrscr subroutine
093
094          mov ax, 30
095          push ax          ; push x position
096          mov ax, 20
097          push ax          ; push y position
098          mov ax, 0x71    ; blue on white attribute
099          push ax          ; push attribute
100         mov ax, message
101         push ax          ; push address of message
102         call printstr    ; call the printstr subroutine
103
104         mov ax, 0x4c00    ; terminate program
105         int 0x21

```

036 The LES instruction is used to load the DI register from BP+4 and the ES register from BP+6.

065 The convention to return a value from a subroutine is to use the AX register. That is why AX is not saved and restored in the subroutine.

Inside the debugger observe that the segment register is pushed followed by the offset. The higher address FFE6 contains the segment and the lower address FFE4 contains the offset. This is because we have a decrementing stack. Then observe the loading of ES and DI from the stack.

7.6. MOVS EXAMPLE – SCREEN SCROLLING

MOVS has the two forms MOVSB and MOVSW. REP allows the instruction to be repeated CX times allowing blocks of memory to be copied. We will perform this copy of the video screen.

Scrolling is the process when all the lines on the screen move one or more lines towards the top of towards the bottom and the new line that appears on the top or the bottom is cleared. Scrolling is a process on which string movement is naturally applicable. REP with MOVS will utilize the full processor power to do the scrolling in minimum time.

In this example we want to scroll a variable number of lines given as argument. Therefore we have to calculate the source address, which is 160 times the number of lines to clear. The destination address is 0, which is the top left of the screen. The lines that scroll up are discarded so the source pointer is placed after them. An equal number of lines at the bottom are cleared. These lines have actually been copied above.

Example 7.5

```
001 ; scroll up the screen
002 [org 0x0100]
003 jmp start
004
005 ; subroutine to scroll up the screen
006 ; take the number of lines to scroll as parameter
007 scrollup: push bp
008          mov bp,sp
009          push ax
010          push cx
011          push si
012          push di
013          push es
014          push ds
015
016          mov ax, 80 ; load chars per row in ax
017          mul byte [bp+4] ; calculate source position
018          mov si, ax ; load source position in si
019          push si ; save position for later use
020          shl si, 1 ; convert to byte offset
021          mov cx, 2000 ; number of screen locations
022          sub cx, ax ; count of words to move
023          mov ax, 0xb800
024          mov es, ax ; point es to video base
025          mov ds, ax ; point ds to video base
026          xor di, di ; point di to top left column
027          cld ; set auto increment mode
028          rep movsw ; scroll up
029          mov ax, 0x0720 ; space in normal attribute
030          pop cx ; count of positions to clear
031          rep stosw ; clear the scrolled space
032
033          pop ds
034          pop es
035          pop di
036          pop si
037          pop cx
038          pop ax
039          pop bp
040          ret 2
041
042 start: mov ax,5
043        push ax ; push number of lines to scroll
044        call scrollup ; call the scroll up subroutine
045
046        mov ax, 0x4c00 ; terminate program
047        int 0x21
```

The beauty of this example is that the two memory blocks are overlapping. If the source and destination in the above algorithm are swapped in an expectation to scroll down the result is strange. For example if 5 lines were to scroll down, the top five lines of the screen are repeated on the whole screen. This is where the use of the direction flag comes in.

When the source is five lines below the destination, the first five lines are copied on the first five lines of the destination. However the next five lines to be copied from the source have been destroyed in the process; because they were the same as the first five lines of the destination. The same is the problem with every set of five lines as the source is destroyed during the previous copy. In this situation we must go from bottom of the screen towards the top. Now the last five lines are copied to the last five lines of the destination. The next five lines are copied to next five lines of the destination destroying the last five lines of source; but now these lines are no longer needed and have been previously copied. Therefore the copy will be appropriately done in this case.

We give an example of scrolling down with this consideration. Now we have to calculate the end of the block instead of the start.

Example 7.6

```

001 ; scroll down the screen
002 [org 0x0100]
003     jmp  start
004
005 ; subroutine to scrolls down the screen
006 ; take the number of lines to scroll as parameter
007 scrolldown:  push bp
008             mov  bp,sp
009             push ax
010             push cx
011             push si
012             push di
013             push es
014             push ds
015
016             mov  ax, 80             ; load chars per row in ax
017             mul  byte [bp+4]       ; calculate source position
018             push ax                ; save position for later use
019             shl  ax, 1             ; convert to byte offset
020             mov  si, 3998          ; last location on the screen
021             sub  si, ax            ; load source position in si
022             mov  cx, 2000          ; number of screen locations
023             sub  cx, ax            ; count of words to move
024             mov  ax, 0xb800
025             mov  es, ax            ; point es to video base
026             mov  ds, ax            ; point ds to video base
027             mov  di, 3998          ; point di to lower right column
028             std                     ; set auto decrement mode
029             rep  movsw              ; scroll up
030             mov  ax, 0x0720        ; space in normal attribute
031             pop  cx                ; count of positions to clear
032             rep  stosw              ; clear the scrolled space
033
034             pop  ds
035             pop  es
036             pop  di
037             pop  si
038             pop  cx
039             pop  ax
040             pop  bp
041             ret  2
042
043 start:      mov  ax,5
044             push ax                ; push number of lines to scroll
045             call scrolldown         ; call scroll down subroutine
046
047             mov  ax, 0x4c00        ; terminate program
048             int  0x21

```

7.7. CMPS EXAMPLE – STRING COMPARISON

For the last string instruction, we take string comparison as an example. The subroutine will take two segment offset pairs containing the address of the two null terminated strings. The subroutine will return 0 if the strings are different and 1 if they are same. The AX register will be used to hold the return value.

Example 7.7

```

001 ; comparing null terminated strings
002 [org 0x0100]
003     jmp  start
004
005 msg1:  db  'hello world', 0
006 msg2:  db  'hello WORLD', 0
007 msg3:  db  'hello world', 0
008
009-031 ;;;; COPY LINES 028-050 FROM EXAMPLE 7.4 (strlen) ;;;;
032
033 ; subroutine to compare two strings
034 ; takes segment and offset pairs of two strings to compare

```

```

035      ; returns 1 in ax if they match and 0 other wise
036      strcmp:      push bp
037                      mov  bp,sp
038                      push cx
039                      push si
040                      push di
041                      push es
042                      push ds
043
044                      lds  si, [bp+4]      ; point ds:si to first string
045                      les  di, [bp+8]      ; point es:di to second string
046
047                      push ds      ; push segment of first string
048                      push si      ; push offset of first string
049                      call strlen   ; calculate string length
050                      mov  cx, ax     ; save length in cx
051
052                      push es      ; push segment of second string
053                      push di      ; push offset of second string
054                      call strlen   ; calculate string length
055                      cmp  cx, ax     ; compare length of both strings
056                      jne  exitfalse  ; return 0 if they are unequal
057
058                      mov  ax, 1      ; store 1 in ax to be returned
059                      repe cmpsb    ; compare both strings
060                      jcxz exitsimple ; are they successfully compared
061
062      exitfalse:    mov  ax, 0      ; store 0 to mark unequal
063
064      exitsimple:  pop  ds
065                      pop  es
066                      pop  di
067                      pop  si
068                      pop  cx
069                      pop  bp
070                      ret  8
071
072      start:      push ds      ; push segment of first string
073                      mov  ax, msg1
074                      push ax      ; push offset of first string
075                      push ds      ; push segment of second string
076                      mov  ax, msg2
077                      push ax      ; push offset of second string
078                      call strcmp  ; call strcmp subroutine
079
080                      push ds      ; push segment of first string
081                      mov  ax, msg1
082                      push ax      ; push offset of first string
083                      push ds      ; push segment of third string
084                      mov  ax, msg3
085                      push ax      ; push offset of third string
086                      call strcmp  ; call strcmp subroutine
087
088                      mov  ax, 0x4c00 ; terminate program
089                      int  0x21

```

005-007	Three strings are declared out of which two are equal and one is different.
044-045	LDS and LES are used to load the pointers to the two strings in DS:SI and ES:DI.
070	Since there are 4 parameters to the subroutine “ret 8” is used.

Inside the debugger we observe that REPE is shown as REP. This is because REP and REPE are represented with the same prefix byte. When used with STOS, LODS, and MOVS it functions as REP and when used with SCAS and CMPS it functions as REPE.

EXERCISES

1. Write code to find the byte in AL in the whole megabyte of memory such that each memory location is compared to AL only once.

Computer Architecture & Assembly Language Programming	Course Code: CS401
CS401@vu.edu.pk	VU

2. Write a far procedure to reverse an array of 64k words such that the first element becomes the last and the last becomes the first and so on. For example if the first word contained 0102h, this value is swapped with the last word. The next word is swapped with the second last word and so on. The routine will be passed two parameters through the stack; the segment and offset of the first element of the array.
3. Write a near procedure to copy a given area on the screen at the center of the screen without using a temporary array. The routine will be passed top, left, bottom, and right in that order through the stack. The parameters passed will always be within range the height will be odd and the width will be even so that it can be exactly centered.
4. Write code to find two segments in the whole memory that are exactly the same. In other words find two distinct values which if loaded in ES and DS then for every value of SI [DS:SI]=[ES:SI].
5. Write a function writechar that takes two parameters. The first parameter is the character to write and the second is the address of a memory area containing top, left, bottom, right, current row, current column, normal attribute, and cursor attribute in 8 consecutive bytes. These define a virtual window on the screen.
The function writes the passed character at (current row, current column) using the normal attribute. It then increments current column, If current column goes outside the window, it makes it zero and increments current row. If current row gets out of window, it scrolls the window one line up, and blanks out the new line in the window. In the end, it sets the attribute of the new (current row, current column) to cursor attribute.
6. Write a function "strcpy" that takes the address of two parameters via stack, the one pushed first is source and the second is the destination. The function should copy the source on the destination including the null character assuming that sufficient space is reserved starting at destination.

Software Interrupts

8.1. INTERRUPTS

Interrupts in reality are events that occurred outside the processor and the processor must be informed about them. Interrupts are asynchronous and unpredictable. Asynchronous means that the interrupts occur, independent of the working of the processor, i.e. independent of the instruction currently executing. Synchronous events are those that occur side by side with another activity. Interrupts must be asynchronous as they are generated by the external world which is unaware of the happenings inside the processor. True interrupts that occur in real time are asynchronous with the execution. Also it is unpredictable at which time an interrupt will come. The two concepts of being unpredictable and asynchronous are overlapping. Unpredictable means the time at which an interrupt will come cannot be predicted, while asynchronous means that the interrupt has nothing to do with the currently executing instruction and the current state of the processor.

The 8088 processor divides interrupts into two classes. Software interrupts and hardware interrupts. Hardware interrupts are the real interrupts generated by the external world as discussed above. Software interrupts on the contrary are not generated from outside the processor. They just provide an extended far call mechanism. Far all allows us to jump anywhere in the whole megabyte of memory. To return from the target we place both the segment and offset on the stack. Software interrupts show a similar behavior. It however pushes one more thing before both the segment and offset and that is the FLAGS register. Just like the far call loads new values in CS and IP, the interrupt call loads new values in CS, IP, and FLAGS. Therefore the only way to retain the value of original FLAGS register is to push and pop as part of interrupt call and return instructions. Pushing and popping inside the routine will not work as the routine started with an already tampered value.

The discussion of real time interrupts is deferred till the next chapter. They play the critical part in control applications where external hardware must be control and events and changes therein must be appropriately responded by the processor. To generate an interrupt the INT instruction is used. The routine that executes in response to an INT instruction is called the interrupt service routine (ISR) or the interrupt handler. Taking example from real time interrupts the routine to instruct an external hardware to close the valve of a boiler in response to an interrupt from the pressure sensor is an interrupt routine.

The software interrupt mechanism in 8088 uses vectored interrupts meaning that the address of the interrupt routine is not directly mentioned in an interrupt call, rather the address is lookup up from a table. 8088 provides a mechanism for mapping interrupts to interrupt handlers. Introducing a new entry in this mapping table is called hooking an interrupt.

Syntax of the INT instruction is very simple. It takes a single byte argument varying from 0-255. This is the interrupt number informing the processor, which interrupt is currently of interest. This number correlates to the interrupt handler routine by a routing or vectoring mechanism. A few interrupt numbers in the start are reserved and we generally do not use them. They are related to the processor working. For example INT 0 is the

Computer Architecture & Assembly Language Programming	Course Code: CS401
CS401@vu.edu.pk	VU

divide by zero interrupt. A list of all reserved interrupts is given later. Such interrupts are programmed in the hardware to generate the designated interrupt when the specified condition arises. The remaining interrupts are provided by the processor for our use. Some of these were reserved by the IBM PC designers to interface user programs with system software like DOS and BIOS. This was the logical choice for them as interrupts provided a very flexible architecture. The remaining interrupts are totally free for use in user software.

The correlation process from the interrupt number to the interrupt handler uses a table called interrupt vector table. Its location is fixed to physical memory address zero. Each entry of the table is four bytes long containing the segment and offset of the interrupt routine for the corresponding interrupt number. The first two bytes in the entry contain the offset and the next two bytes contain the segment. The little endian rule of putting the more significant part (segment) at a higher address is seen here as well. Mathematically offset of the interrupt n will be at $nx4$ while the segment will be at $nx4+2$. One entry in this table is called a vector. If the vector is changed for interrupt 0 then INT 0 will take execution to the new handler whose address is now placed at those four bytes. INT 1 vector occupies location 4, 5, 6, and 7 and similarly vector for INT 2 occupies locations 8, 9, 10, and 11. As the table is located in RAM it can be changed anytime. Immediately after changing it the interrupt mapping is changed and now the interrupt will result in execution of the new routine. This indirection gives the mechanism extreme flexibility.

The operation of interrupt is same whether it is the result of an INT instruction (software interrupt) or it is generated by an external hardware which passes the interrupt number by a different mechanism. The currently executing instruction is completed, the current value of FLAGS is pushed on the stack, then the current code segment is pushed, then the offset of the next instruction is pushed. After this it automatically clears the trap flag and the interrupt flag to disallow further interrupts until the current routine finishes. After this it loads the word at $nx4$ in IP and the word at $nx4+2$ in CS if interrupt n was generated. As soon as these values are loaded in CS and IP execution goes to the start of the interrupt handler. When the handler finishes its work it uses the IRET instruction to return to the caller. IRET pops IP, then CS, and then FLAGS. The original value of IF and TF is restored which re-enables further interrupts. IF and TF will be discussed in detail in the discussion of real time interrupts. We have discussed three things till now.

1. The INT and IRET instruction format and syntax
2. The formation of IVT (interrupt vector table)
3. Operation of the processor when an interrupt is generated

Just as discussed in the subroutines chapter, the processor will not match interrupt calls to interrupt returns. If a RETF is used in the end of an ISR the processor will still return to the caller but the FLAGS will remain on the stack which will destroy the expectations of the caller with the stack. If we know what we are doing we may use such different combination of instructions. Generally we will use IRET to return from an interrupt routine. Apart from indirection the software interrupt mechanism is similar to CALL and RET. Indirection is the major difference.

The operation of INT can be written as:

- $sp \leftarrow sp+2$
- $[sp] \leftarrow flag$
- $sp \leftarrow sp+2$
- $if \leftarrow 0$
- $tf \leftarrow 0$
- $[sp] \leftarrow cs$
- $sp \leftarrow sp+2$
- $[sp] \leftarrow ip$

Computer Architecture & Assembly Language Programming	Course Code: CS401
CS401@vu.edu.pk	VU

- $ip \leftarrow [0:N*4]$
- $cs \leftarrow [0:N*4+2]$

The operation of IRET can be written as:

- $ip \leftarrow [sp]$
- $sp \leftarrow sp-2$
- $cs \leftarrow [sp]$
- $sp \leftarrow sp-2$
- $flag \leftarrow [sp]$
- $sp \leftarrow sp-2$

The above is the microcode description of INT and IRET. To obey an assembly language instruction the processor breaks it down into small operations. By reading the microcode of an instruction its working can be completely understood.

The interrupt mechanism we have studied is an extended far call mechanism. It pushes FLAGS in addition to CS and IP and it loads CS and IP with a special mechanism of indirection. It is just like the table of contents that is located at a fixed position and allows going directly to chapter 3, to chapter 4 etc. If this association is changed in the table of contents the direction of the reader changes. For example if Chapter 2 starts at page 220 while 240 is written in the table of contents, the reader will go to page 240 and not 220. The table of contents entry is a vector to point to map the chapter number to page number. IVT has 256 chapters and the interrupt mechanism looks up the appropriate chapter number to reach the desired page to find the interrupt routine.

Another important similarity is that table of contents is always placed at the start of the book, a well known place. Its physical position is fixed. If some publishers put it at some place, others at another place, the reader will be unable to find the desired chapter. Similarly in 8088 the physical memory address zero is fixed for the IVT and it occupies exactly a kilobyte of memory as the $256 \times 4 = 1K$ where 256 is the number of possible interrupt vectors while the size of one vector is 4 bytes.

Interrupts introduce temporary breakage in the program flow, sometimes programmed (software interrupts) and un-programmed at other times (hardware interrupts). By hooking interrupts various system functionalities can be controlled. The interrupts reserved by the processor and having special functions in 8088 are listed below:

- INT 0, Division by zero
Meaning the quotient did not fit in the destination register. This is a bit different as this interrupt does not return to the next instruction, rather it returns to the same instruction that generated it, a DIV instruction of course. Here INT 0 is automatically generated by a DIV when a specific situation arises, there is no INT 0 instruction.
- INT 1, Trap, Single step Interrupt
This interrupt is used in debugging with the trap flag. If the trap flag is set the Single Step Interrupt is generated after every instruction. By hooking this interrupt a debugger can get control after every instruction and display the registers etc. 8088 was the first processor that has this ability to support debugging.
- INT 2, NMI-Non Maskable Interrupt
Real interrupts come from outside the processor. INT 0 is not real as it is generated from inside. For real interrupts there are two pins in the processor, the INT pin and the NMI pin. The processor can be directed to listen or not to listen to the INT pin. Consider a recording studio, when the recording is going on, doors are closed so that no interruption occurs, and when there is a break, the doors are opened so that if someone is waiting outside can come in. However if there is an urgency like fire outside then the door must be broken and the recording must not be catered for. For such situations is the NMI pin

which informs about fatal hardware failures in the system and is tied to interrupt 2. INT pin can be masked but NMI cannot be masked.

- INT 3, Debug Interrupt
The only special thing about this interrupt is that it has a single byte opcode and not a two byte combination where the second byte tells the interrupt number. This allows it to replace any instruction whatsoever. It is also used by the debugger and will be discussed in detail with the debugger working.
- INT 4, Arithmetic Overflow, change of sign bit
The overflow flag is set if the sign bit unexpectedly changes as a result of a mathematical or logical instruction. However the overflow flag signals a real overflow only if the numbers in question are treated as signed numbers. So this interrupt is not automatically generated but as a result of a special instruction INTO (interrupt on overflow) if the overflow flag is set. Otherwise the INTO instruction behaves like a NOP (no operation).

These are the five interrupts reserved by Intel and are generally not used in our operations.

8.2. HOOKING AN INTERRUPT

To hook an interrupt we change the vector corresponding to that interrupt. As soon as the interrupt vector changes, that interrupt will be routed to the new handler. Our first example is with the divide by zero interrupt. The normal system defined behavior in response to divide by zero is to display an error message and terminate the program. We will change it to display our own message.

Example 8.1

```

001 ; hooking divide by zero interrupt
002 [org 0x0100]
003 jmp start
004
005 message: db 'You divided something by zero.', 0
006
007-029 ;;;; COPY LINES 028-050 FROM EXAMPLE 7.4 (strlen) ;;;;
030-049 ;;;; COPY LINES 005-024 FROM EXAMPLE 7.1 (clrscr) ;;;;
050-090 ;;;; COPY LINES 050-090 FROM EXAMPLE 7.4 (printstr) ;;;;
091
092 ; divide by zero interrupt handler
093 myisrfor0: push ax ; push all regs
094 push bx
095 push cx
096 push dx
097 push si
098 push di
099 push bp
100 push ds
101 push es
102
103 push cs
104 pop ds ; point ds to our data segment
105
106 call clrscr ; clear the screen
107 mov ax, 30
108 push ax ; push x position
109 mov ax, 20
110 push ax ; push y position
111 mov ax, 0x71 ; white on blue attribute
112 push ax ; push attribute
113 mov ax, message
114 push ax ; push offset of message
115 call printstr ; print message
116
117 pop es
118 pop ds
119 pop bp

```

```

120         pop di
121         pop si
123         pop dx
124         pop cx
125         pop bx
126         pop ax
127         iret                ; return from interrupt
128
129         ; subroutine to generate a divide by zero interrupt
130 genint0:  mov ax, 0x8432      ; load a big number in ax
131         mov bl, 2            ; use a very small divisor
132         div bl              ; interrupt 0 will be generated
133         ret
134
135 start:    xor ax, ax
136         mov es, ax          ; load zero in es
137         mov word [es:0*4], myisrfor0 ; store offset at n*4
138         mov [es:0*4+2], cs   ; store segment at n*4+2
139         call genint0        ; generate interrupt 0
140
141         mov ax, 0x4c00      ; terminate program
142         int 0x21

```

93-101 We often push all registers in an interrupt service routine just to be sure that no unintentional modification to any register is made. Since any code may be interrupted an unintentional modification will be hard to debug

103-104 Since interrupt can be called from anywhere we are not sure about the value in DS so we reset it to our code segment.

When this program is executed our desired message will be shown instead of the default message and the computer will hang thereafter. The first thing to observe is that there is no INT 0 call anywhere in the code. INT 0 was invoked automatically by an internal mechanism of the processor as a result of the DIV instruction producing a result that cannot fit in the destination register. Just by changing the vector we have changed the response of the system to divide overflow situations.

However the system stuck instead of returning to the next instruction. This is because divide overflow is a special type of interrupt that returns to the same instruction instead of the next instruction. This is why the default handler forcefully terminates the program instead of returning. Now the IRET will take control back to the DIV instruction which will again generate the same interrupt. So the computer is stuck in an infinite loop.

8.3. BIOS AND DOS INTERRUPTS

In IBM PC there are certain interrupts designated for user programs to communicate with system software to access various standard services like access to the floppy drive, hard drive, vga, clock etc. If the programmer does not use these services he has to understand the hardware details like which particular controller is used and how it works. To avoid this and provide interoperability a software interface to basic hardware devices is provided except in very early computers. Since the manufacturer knows the hardware it burns the software to control its hardware in ROM. Such software is called firmware and access to this firmware is provided through specified interrupts.

This basic interface to the hardware is called BIOS (basic input output services). When the computer is switched on, BIOS gets the control at a specified address. The messages at boot time on the screen giving BIOS version, detecting different hardware are from this code. BIOS has the responsibility of testing the basic hardware including video, keyboard, floppy drive, hard drive etc and a special program to bootstrap. Bootstrap means to load OS from hard disk and from there OS takes control and proceeds to load its components and display a command prompt in the end. There are two

Computer Architecture & Assembly Language Programming	Course Code: CS401
CS401@vu.edu.pk	VU

important programs; BIOS and OS. OS services are high level and build upon the BIOS services. BIOS services are very low level. A level further lower is only directly controlling the hardware. BIOS services provide a hardware independent layer above the hardware and OS services provide another higher level layer over the BIOS services. We have practiced direct hardware access with the video device directly without using BIOS or DOS. The layer of BIOS provides services like display a character, clear the screen, etc. All these layers are optional in that we can skip to whatever lower layer we want.

The most logical way to provide access to firmware is to use the interrupt mechanism. Specific services are provided at specific interrupts. CALL could also have been used but in that case every manufacturer would be required to place specific routines at specific addresses, which is not a flexible mechanism. Interrupts provide standard interrupt number for the caller and flexibility to place the interrupt routine anywhere in the memory for the manufacturer. Now for the programmer it is decided that video services will be provided at INT 10 but the actual address of the video services can and do vary on computers from different manufacturers. Any computer that is IBM compatible must make the video services accessible through INT 10. Similarly keyboard services are available at INT 16 and this is standard in every IBM compatible. Manufacturers place the code wherever they want and the services are exported through this interrupt.

BIOS exports its various services through different interrupts. Keyboard services are exported through INT 16, parallel port services through INT 17 and similarly others through different interrupts. DOS has a single entry point through INT 21 just like a pin hole camera, this single entry points leads to a number of DOS services. So how one interrupt provides a number of different services. A concept of service number is used here which is a defecto standard in providing multiple services through an interrupt. INT 10 is for video services and each of character printing service, screen clearing service, cursor movement service etc. has a service number associated to it. So we say INT 10 service 0 is used for this purpose and INT 10 service 1 is used for that purpose etc. Service numbers for different standard services are also fixed for every IBM compatible. The concept of exported services through interrupts is expanded with the service numbering scheme.

The service number is usually given in the AH register. Sometimes these 256 services seem less. For example DOS exports thousands of services. So will be often seen an extension to a level further with sub-services. For examples INT 10 character generator services are all provided through a single service number and the services are distinguished with a sub-service number.

The finally selected service would need some arguments for it to work. In interrupts arguments are usually not given through stack, rather registers are used. The BIOS and DOS specifications list which register contains which argument for a particular service of a particular interrupt.

We will touch some important BIOS and DOS services and not cover it completely neither is it possible to cover it in this space. A very comprehensive reference of interrupts is the Ralph Brown List. It is just a reference and not to be studied from end to end. All interrupts cannot be remembered and there is no need to remember them.

The service number is almost always in AH while the sub-service number is in AL or BL and sometimes in other registers. The documentation of the service we are using will list which register should hold what when the interrupt is invoked for that particular service.

Our first target using BIOS is video so let us proceed to our first program that uses INT 10 service 13 to print a string on the screen. BIOS will work even if the video memory is not at B8000 (a very old video card) since BIOS knows everything about the hardware and is hardware specific.

Example 8.2	
001	<code>; print string using bios service</code>
002	<code>[org 0x0100]</code>
003	<code>jmp start</code>
004	<code>message: db 'Hello World'</code>
005	
006	<code>start: mov ah, 0x13 ; service 13 - print string</code>
007	<code>mov al, 1 ; subservice 01 - update cursor</code>
008	<code>mov bh, 0 ; output on page 0</code>
009	<code>mov bl, 7 ; normal attrib</code>
010	<code>mov dx, 0x0A03 ; row 10 column 3</code>
011	<code>mov cx, 11 ; length of string</code>
012	<code>push cs</code>
013	<code>pop es ; segment of string</code>
014	<code>mov bp, message ; offset of string</code>
015	<code>int 0x10 ; call BIOS video service</code>
016	
017	<code>mov ax, 0x4c00 ; terminate program</code>
018	<code>int 0x21</code>
007	The sub-service are versions of printstring that update and do not update the cursor after printing the string etc.
008	Text video screen is in the form of pages which can be upto 32. At one time one page is visible which is by default the zeroth page unless we change it.

When we execute it the string is printed and the cursor is updated as well. With direct access to video memory we had no control over the cursor. To control cursor a different mechanism to access the hardware was needed.

Our next example uses the keyboard service to read a key. The combination of keyboard and video services is used in almost every program that we see and use. We will wait for four key presses; clear the screen after the first, and draw different strings after the next key presses and exiting after the last. We will use INT 16 service 1 for this purpose. This is a blocking service so it does not return until a key has been pressed. We also used the blinking attribute in this example.

Example 8.3

```

001      ; print string and keyboard wait using BIOS services
002      [org 0x100]
003      jmp start
004
005      msg1:      db 'hello world', 0
006      msg2:      db 'hello world again', 0
007      msg3:      db 'hello world again and again', 0
008
009-028  ;;;; COPY LINES 005-024 FROM EXAMPLE 7.1 (clrscr) ;;;;
029-069  ;;;; COPY LINES 050-090 FROM EXAMPLE 7.4 (printstr) ;;;;
070-092  ;;;; COPY LINES 028-050 FROM EXAMPLE 7.4 (strlen) ;;;;
093
094      start:      mov ah, 0x10          ; service 10 - vga attributes
095                      mov al, 03          ; subservice 3 - toggle blinking
096                      mov bl, 01          ; enable blinking bit
097                      int 0x10           ; call BIOS video service
098
099                      mov ah, 0           ; service 0 - get keystroke
100                      int 0x16           ; call BIOS keyboard service
101
102                      call clrscr         ; clear the screen
103
104                      mov ah, 0           ; service 0 - get keystroke
105                      int 0x16           ; call BIOS keyboard service
106
107                      mov ax, 0
108                      push ax             ; push x position
109                      mov ax, 0
110                      push ax            ; push y position
111                      mov ax, 1          ; blue on black
112                      push ax            ; push attribute
113                      mov ax, msg1
114                      push ax             ; push offset of string
115                      call printstr      ; print the string
116
117                      mov ah, 0           ; service 0 - get keystroke
118                      int 0x16           ; call BIOS keyboard service
119
120                      mov ax, 0
121                      push ax             ; push x position
122                      mov ax, 0
123                      push ax            ; push y position
124                      mov ax, 0x71       ; blue on white
125                      push ax            ; push attribute
126                      mov ax, msg2
127                      push ax             ; push offset of string
128                      call printstr      ; print the string
129
130                      mov ah, 0           ; service 0 - get keystroke
131                      int 0x16           ; call BIOS keyboard service
132
133                      mov ax, 0
134                      push ax             ; push x position
135                      mov ax, 0
136                      push ax            ; push y position
137                      mov ax, 0xF4       ; red on white blinking
138                      push ax            ; push attribute
139                      mov ax, msg3
140                      push ax             ; push offset of string
141                      call printstr      ; print the string
142
143                      mov ah, 0           ; service 0 - get keystroke
144                      int 0x16           ; call BIOS keyboard service
145
146                      mov ax, 0x4c00     ; terminate program
147                      int 0x21
148

```

099-100 This service has no parameters so only the service number is initialized in AH. This is the only service so there is no sub-service number as well. The ASCII code of the char pressed is returned in AL after this service.

Computer Architecture & Assembly Language Programming	Course Code: CS401
CS401@vu.edu.pk	VU

EXERCISES

1. Write a TSR that forces a program to exit when it tries to become a TSR using INT 21h/Service 31h by converting its call into INT 21h/Service 4Ch.
2. Write a function to clear the screen whose only parameter is always zero. The function is hooked at interrupt 80h and may also be called directly both as a near call and as a far call. The function should detect how it is called and return appropriately. It is provided that the direction flag will be set before the function is called.
3. Write a function that takes three parameters, the interrupt number (N) and the segment and offset of an interrupt handler XISR. The arguments are pushed in the order N, XISR's offset and XISR's segment. It is known that the first two instructions of XISR are PUSHF and CALL 0:0 followed by the rest of the interrupt handler. PUSHF instruction is of one byte and far call is of 5 bytes with the first byte being the op-code, the next two containing the target offset and the last two containing the target segment. The function should hook XISR at interrupt N and chain it to the interrupt handler previously hooked at N by manipulating the call 0:0 instruction placed near the start of XISR.
4. Write a TSR that provide the circular queue services via interrupt 0x80 using the code written in Exercise 5.XX. The interrupt procedure should call one of qcreate, qdestroy, qempty, qadd, qremove, and uninstall based on the value in AH. The uninstall function should restore the old interrupt 0x80 handler and remove the TSR from memory.

Real Time Interrupts and Hardware Interfacing

9.1. HARDWARE INTERRUPTS

The same mechanism as discussed in the previous chapter is used for real interrupts that are generated by external hardware. However there is a single pin outside the processor called the INT pin that is used by external hardware to generate interrupts. The detailed operation that happens outside the process when an interrupt is generated is complex and only a simplified view will be discussed here; the view that is relevant to an assembly language programmer. There are many external devices that need the processor's attention like the keyboard, hard disk, floppy disk, sound card. All of them need real time interrupts at some point in their operation. For example if a program is busy in some calculations for three minutes the key strokes that are hit meanwhile should not be wasted. Therefore when a key is pressed, the INT signal is sent, an interrupt generated and the interrupt handler stores the key for later use. Similarly when the printer is busy printing we cannot send it more data. As soon as it gets free from the previous job it interrupts the processor to inform that it is free now. There are many other examples where the processor needs to be informed of an external event. If the processor actively monitors all devices instead of being automatically interrupted then it there won't be any time to do meaningful work.

Since there are many devices generating interrupts and there is only one pin going inside the processor and one pin cannot be technically derived by more than one source a controller is used in between called the Programmable Interrupt Controller (PIC). It has eight input signals and one output signal. It assigns priorities to its eight input pins from 0 to 7 so that if more than one interrupt comes at the same times, the highest priority one is forwarded and the rest are held till that is serviced. The rest are forwarded one by one according to priority after the highest priority one is completed. The original IBM XT computer had one PIC so there were 8 possible interrupt sources. However IBM AT and later computers have two PIC totaling 16 possible interrupt sources. They are arranged in a special cascade master slave arrangement so that only one output signal comes towards the processor. However we will concentrate on the first interrupt controller only.

The priority can be understood with the following example. Consider eight parallel switches which are all closed and connected to form the output signal. When a signal comes on one of the switches, it is passed on to the output and this switch and all below it are opened so that no further signals can pass through it. The higher priority switches are still closed and the signal on them can be forwarded. When the processor signals that it is finished with the processing the switches are closed again and any waiting interrupts may be forwarded. The way the processor signals ending of the interrupt service routine is by using a special mechanism discussed later.

The eight input signals to the PIC are called Interrupt Requests (IRQ). The eight lines are called IRQ 0 to IRQ 7. These are the input lines of the 8451.[†] For example IRQ 0 is derived by a timer device. The timer device keeps

[†] 8451 is the technical number of the PIC.

Computer Architecture & Assembly Language Programming	Course Code: CS401
CS401@vu.edu.pk	VU

generating interrupts with a specified frequency. IRQ 1 is derived by the keyboard when generates an interrupts when a key is pressed or released. IRQ 2 is the cascading interrupt connected to the output of the second 8451 in the machine. IRQ 3 is connected to serial port COM 2 while IRQ 4 is connected to serial port COM 1. IRQ 5 is used by the sound card or the network card or the modem. An IRQ conflict means that two devices in the system want to use the same IRQ line. IRQ 6 is used by the floppy disk drive while IRQ 7 is used by the parallel port.

Each IRQ is mapped to a specific interrupt in the system. This is called the IRQ to INT mapping. IRQ 0 to IRQ 7 are consecutively mapped on interrupts 8 to F. This mapping is done by the PIC and not the processor. The actual mechanism fetches one instruction from the PIC whenever the INT pin is signaled instead of the memory. We can program the PIC to generate a different set of interrupts on the same interrupt requests. From the perspective of an assembly language programmer an IRQ 0 is translated into an INT 8 without any such instruction in the program and that's all. Therefore an IRQ 0, the highest priority interrupt, is generated by the timer chip at a precise frequency and the handler at INT 8 is invoked which updates the system time. A key press generates IRQ 1 and the INT 9 handler is invoked which stores this key. To handler the timer and keyboard interrupts one can replace the vectors corresponding to interrupt 8 and 9 respectively. For example if the timer interrupt is replaced and the floppy is accessed by some program, the floppy motor and its light will remain on for ever as in the normal case it is turned off by the timer interrupt after two seconds in anticipation that another floppy access might be needed otherwise the time motor takes to speed up will be needed again.‡

We have seen that an interrupt request from a device enters the PIC as an IRQ, from there it reaches the INT pin of the processor, the processor receives the interrupt number from the PIC, generates the designated interrupt, and finally the interrupt handler gain control and can do whatever is desired. At the end of servicing the interrupt the handler should inform the PIC that it is completed so that lower priority interrupts can be sent from the PIC. This signal is called an End Of Interrupt (EOI) signal and is sent through the I/O ports of the interrupt controller.

9.2. I/O PORTS

There are hundreds of peripheral devices in the system, PIC is one example. The processor needs to communicate with them, give and take data from them, otherwise their presence is meaningless. Memory has a totally different purpose. It contains the program to be executed and its data. It does not control any hardware. For communicating with peripheral devices the processor uses I/O ports. There are only two operations with the external world possible, read or write. Similarly with I/O ports the processor can read or write an I/O port. When an I/O port is read or written to, the operation is not as simple as it happens in memory. Some hardware changes it functionality or performs some operation as a result.

IBM PC has separate memory address space and peripheral address space. Some processors use memory mapped I/O in which case designated memory cells work as ports for specific devices. In case of Intel a special pin on the control bus signals whether the current read or write is from the memory address space or from the peripheral address space. The same address and data buses are used to select a port and to read or write data from that port. However with I/O only the lower 16 bits of the address bus are used meaning that there are a total of 65536 possible I/O ports. Now keyboard has special

‡ The programs discussed from now onwards in the book must be executed in pure DOS and not in a DOS window so that we are in total control of the PIC and other devices.

Computer Architecture & Assembly Language Programming	Course Code: CS401
CS401@vu.edu.pk	VU

I/O ports designated to it, PIC has others, DMA, sound card, network card, each has some ports.

If the two address spaces are differentiated in hardware, they must also have special instructions to select the other address space. We have the IN and OUT instructions to read or write from the peripheral address space. When MOV is given the processor selects the memory address space, when IN is given the processor selects the peripheral address space.

IN and OUT instructions

The IN and OUT instructions have a byte form and a word form but the byte form is almost always used. The source register in OUT and destination register in IN is AL or AX depending on which form is used. The port number can be directly given in the instruction if it fits in a byte otherwise it has to be given in the DX register. Port numbers for specific devices are fixed by the IBM standard. For example 20 and 21 are for PIC, 60 to 64 for Keyboard, 378 for the parallel port etc. A few example of IN and OUT are below:

```
in al, 0x21
mov dx, 0x378
in al, dx
out 0x21, al
mov dx, 0x378
out dx, al
```

PIC Ports

Programmable interrupt controller has two ports 20 and 21. Port 20 is the control port while port 21 is the interrupt mask register which can be used for selectively enabling or disabling interrupts. Each of the bits at port 21 corresponds to one of the IRQ lines. We first write a small program to disable the keyboard using this port. As we know that the keyboard IRQ is 1, we place a 1 bit at its corresponding position. A 0 bit will enable an interrupt and a 1 bit disables it. As soon as we write it on the port keyboard interrupts will stop arriving and the keyboard will effectively be disabled. Even Ctrl-Alt-Del would not work; the reset power button has to be used.

Example 9.1	
001	; disable keyboard interrupt in PIC mask register
002	[org 0x0100]
003	in al, 0x21 ; read interrupt mask register
004	or al, 2 ; set bit for IRQ2
005	out 0x21, al ; write back mask register
006	
007	mov ax, 0x4c00 ; terminate program
008	int 0x21

After this three line mini program is executed the computer will not understand anything else. Its ears are closed. No keystrokes are making their way to the processor. Ports always make something happen on the system. A properly designed system can launch a missile on writing a bit on some port. Memory is simple in that it is all that it is. In ports every bit has a meaning that changes something in the system.

As we previously discussed every interrupt handler invoked because of an IRQ must signal an EOI otherwise lower priority interrupts will remain disabled.

Keyboard Controller

We will go in further details of the keyboard and its relation to the computer. We will not discuss how the keyboard communicates with the keyboard controller in the computer rather we will discuss how the keyboard

controller communicates with the processor. Keyboard is a collection of labeled buttons and every button is designated a number (not the ASCII code). This number is sent to the processor whenever the key is pressed. From this number called the scan code the processor understands which key was pressed. For each key the scan code comes twice, once for the key press and once for the key release. Both are scan codes and differ in one bit only. The lower seven bits contain the key number while the most significant bit is clear in the press code and set in the release code. The IBM PC standard gives a table of the scan codes of all keys.

If we press Shift-A resulting in a capital A on the screen, the controller has sent the press code of Shift, the press code of A, the release code of A, the release code of Shift and the interrupt handler has understood that this sequence should result in the ASCII code of 'A'. The 'A' key always produces the same scan code whether or not shift is pressed. It is the interrupt handler's job to remember that the press code of Shift has come and release code has not yet come and therefore to change the meaning of the following key presses. Even the caps lock key works the same way.

An interesting thing is that the two shift keys on the left and right side of the keyboard produce different scan codes. The standard way implemented in BIOS is to treat that similarly. That's why we always think of them as identical. If we leave BIOS and talk directly with the hardware we can differentiate between left and right shift keys with their scan code. Now this scan code is available from the keyboard data port which is 60. The keyboard generates IRQ 1 whenever a key is pressed so if we hook INT 9 and inside it read port 60 we can tell which of the shift keys was hit. Our first program will do precisely this. It will output an L if the left shift key was pressed and R if the right one was pressed. The hooking method is the same as done in the previous chapter.

Example 9.2

```

001 ; differentiate left and right shift keys with scancodes
002 [org 0x0100]
003         jmp start
004
005 ; keyboard interrupt service routine
006 kbisr:  push ax
007         push es
008
009         mov ax, 0xb800
010         mov es, ax           ; point es to video memory
011
012         in  al, 0x60         ; read a char from keyboard port
013         cmp al, 0x2a       ; is the key left shift
014         jne nextcmp       ; no, try next comparison
015
016         mov byte [es:0], 'L' ; yes, print L at top left
017         jmp nomatch       ; leave interrupt routine
018
019 nextcmp: cmp al, 0x36       ; is the key right shift
020         jne nomatch       ; no, leave interrupt routine
021
022         mov byte [es:0], 'R' ; yes, print R at top left
023
024 nomatch: mov al, 0x20
025         out 0x20, al       ; send EOI to PIC
026
027         pop es
028         pop ax
029         iret
030
031 start:   xor ax, ax
032         mov es, ax         ; point es to IVT base
033         cli                ; disable interrupts
034         mov word [es:9*4], kbisr ; store offset at n*4
035         mov [es:9*4+2], cs   ; store segment at n*4+2
036         sti                ; enable interrupts

```

037	
038	ll: jmp ll ; infinite loop
033-036	CLI clears the interrupt flag to disable the interrupt system completely. The processor closes its ears and does not care about the state of the INT pin. Interrupt hooking is done in two instructions, placing the segment and placing the offset. If an interrupt comes in between and the vector is in an indeterminate state, the system will go to a junk address and eventually crash. So we stop all interruptions while changing a real time interrupt vector. We set the interrupt flag afterwards to renewable interrupts.
038	The program hangs in an infinite loop. The only activity can be caused by a real time interrupt. The kbisr routine is not called from anywhere; it is only automatically invoked as a result of IRQ 1.

When the program is executed the left and right shift keys can be distinguished with the L or R on the screen. As no action was taken for the rest of the keys, they are effectively disabled and the computer has to be rebooted. To check that the keyboard is actually disabled we change the program and add the INT 16 service 0 at the end to wait for an Esc key press. As soon as Esc is pressed we want to terminate our program.

Example 9.3	
001	; attempt to terminate program with Esc that hooks keyboard interrupt
002	[org 0x0100]
003	jmp start
004	
005-029	;;;; COPY LINES 005-029 FROM EXAMPLE 9.2 (kbisr) ;;;;
030	
031	start: xor ax, ax
032	mov es, ax ; point es to IVT base
033	cli ; disable interrupts
034	mov word [es:9*4], kbisr ; store offset at n*4
035	mov [es:9*4+2], cs ; store segment at n*4+2
036	sti ; enable interrupts
037	
038	ll: mov ah, 0 ; service 0 - get keystroke
039	int 0x16 ; call BIOS keyboard service
040	
041	cmp al, 27 ; is the Esc key pressed
042	jne ll ; if no, check for next key
043	
044	mov ax, 0x4c00 ; terminate program
045	int 0x21

When the program is executed the behavior is same. Esc does not work. This is because the original IRQ 1 handler was written by BIOS that read the scan code, converted into an ASCII code and stored in the keyboard buffer. The BIOS INT 16 read the key from there and gives in AL. When we hooked the keyboard interrupt BIOS is no longer in control, it has no information, it will always see the empty buffer and INT 16 will never return.

Interrupt Chaining

We can transfer control to the original BIOS ISR in the end of our routine. This way the normal functioning of INT 16 can work as well. We can retrieve the address of the BIOS routine by saving the values in vector 9 before hooking our routine. In the end of our routine we will jump to this address using a special indirect form of the JMP FAR instruction.

Example 9.4

```

001 ; another attempt to terminate program with Esc that hooks
002 ; keyboard interrupt
003 [org 0x100]
004         jmp start
005
006 oldisr:  dd 0 ; space for saving old isr
007
008 ; keyboard interrupt service routine
009 kbisr:  push ax
010        push es
011
012        mov ax, 0xb800
013        mov es, ax ; point es to video memory
014
015        in al, 0x60 ; read a char from keyboard port
016        cmp al, 0x2a ; is the key left shift
017        jne nextcmp ; no, try next comparison
018
019        mov byte [es:0], 'L' ; yes, print L at top left
020        jmp nomatch ; leave interrupt routine
021
022 nextcmp: cmp al, 0x36 ; is the key right shift
023        jne nomatch ; no, leave interrupt routine
024
025        mov byte [es:0], 'R' ; yes, print R at top left
026
027 nomatch: ; mov al, 0x20
028        ; out 0x20, al
029
030        pop es
031        pop ax
032        jmp far [cs:oldisr] ; call the original ISR
033        ; iret
034
035 start:   xor ax, ax
036        mov es, ax ; point es to IVT base
037        mov ax, [es:9*4]
038        mov [oldisr], ax ; save offset of old routine
039        mov ax, [es:9*4+2]
040        mov [oldisr+2], ax ; save segment of old routine
041        cli ; disable interrupts
042        mov word [es:9*4], kbisr ; store offset at n*4
043        mov [es:9*4+2], cs ; store segment at n*4+2
044        sti ; enable interrupts
045
046 ll:    mov ah, 0 ; service 0 - get keystroke
047        int 0x16 ; call BIOS keyboard service
048
049        cmp al, 27 ; is the Esc key pressed
050        jne ll ; if no, check for next key
051
052        mov ax, 0x4c00 ; terminate program
053        int 0x21

```

027-028 EOI is no longer needed as the original BIOS routine will have it at its end.

033 IRET has been removed and an unconditional jump is introduced. At time of JMP the stack has the exact formation as was when the interrupt came. So the original BIOS routine's IRET will take control to the interrupted program. We have been careful in restoring every register we modified and retained the stack in the same form as it was at the time of entry into the routine.

When the program is executed L and R are printed as desired and Esc terminates the program as well. Normal commands like DIR work now and shift keys still show L and R as our routine did even after the termination of our program. Now start some application like the editor, it open well but as soon as a key is pressed the computer crashes.

Actually our hooking and chaining was fine. When Esc was pressed we signaled DOS that our program has terminated. DOS will take all our

memory as a result. The routine is still in memory and functioning but the memory is free according to DOS. As soon as we load EDIT the same memory is allocated to EDIT and our routine is overwritten. Now when a key is pressed our routine's address is in the vector but at that address some new code is placed that is not intended to be an interrupt handler. That may be data or some part of the EDIT program. This results in crashing the computer.

Unhooking Interrupt

We now add the interrupt restoring part to our program. This code resets the interrupt vector to the value it had before the start of our program.

Example 9.5	
001	; terminate program with Esc that hooks keyboard interrupt
002	[org 0x100]
003	jmp start
004	
005	oldisr: dd 0 ; space for saving old isr
006	
007-032	;;;; COPY LINES 005-029 FROM EXAMPLE 9.4 (kbisr) ;;;;
033	
034	start: xor ax, ax
035	mov es, ax ; point es to IVT base
036	mov ax, [es:9*4]
037	mov [oldisr], ax ; save offset of old routine
038	mov ax, [es:9*4+2]
039	mov [oldisr+2], ax ; save segment of old routine
040	cli ; disable interrupts
041	mov word [es:9*4], kbisr ; store offset at n*4
042	mov [es:9*4+2], cs ; store segment at n*4+2
043	sti ; enable interrupts
044	
045	ll: mov ah, 0 ; service 0 - get keystroke
046	int 0x16 ; call BIOS keyboard service
047	
048	cmp al, 27 ; is the Esc key pressed
049	jne ll ; if no, check for next key
050	
051	mov ax, [oldisr] ; read old offset in ax
052	mov bx, [oldisr+2] ; read old segment in bx
053	cli ; disable interrupts
054	mov [es:9*4], ax ; restore old offset from ax
055	mov [es:9*4+2], bx ; restore old segment from bx
056	sti ; enable interrupts
057	
058	mov ax, 0x4c00 ; terminate program
059	int 0x21

9.3. TERMINATE AND STAY RESIDENT

We change the display to show L only while the left shift is pressed and R only while the right shift is pressed to show the use of the release codes. We also changed that shift keys are not forwarded to BIOS. The effect will be visible with A and Shift-A both producing small 'a' but caps lock will work.

There is one major difference from all the programs we have been writing till now. The termination is done using INT 21 service 31 instead of INT 21 service 4C. The effect is that even after termination the program is there and is legally there.

Example 9.6	
001	; TSR to show status of shift keys on top left of screen
002	[org 0x0100]
003	jmp start
004	
005	oldisr: dd 0 ; space for saving old isr
006	

```

007 ; keyboard interrupt service routine
008 kbisr:      push ax
009            push es
010
011            mov ax, 0xb800
012            mov es, ax            ; point es to video memory
013
014            in  al, 0x60          ; read a char from keyboard port
015            cmp al, 0x2a         ; has the left shift pressed
016            jne nextcmp         ; no, try next comparison
017
018            mov byte [es:0], 'L' ; yes, print L at first column
019            jmp exit            ; leave interrupt routine
020
021 nextcmp:    cmp al, 0x36          ; has the right shift pressed
022            jne nextcmp2       ; no, try next comparison
023
024            mov byte [es:0], 'R' ; yes, print R at second column
025            jmp exit            ; leave interrupt routine
026
027 nextcmp2:   cmp al, 0xaa          ; has the left shift released
028            jne nextcmp3       ; no, try next comparison
029
030            mov byte [es:0], ' ' ; yes, clear the first column
031            jmp exit            ; leave interrupt routine
032
033 nextcmp3:   cmp al, 0xb6          ; has the right shift released
034            jne nomatch        ; no, chain to old ISR
035
036            mov byte [es:2], ' ' ; yes, clear the second column
037            jmp exit            ; leave interrupt routine
038
039 nomatch:    pop es
040            pop ax
041            jmp far [cs:oldisr] ; call the original ISR
042
043 exit:       mov al, 0x20
044            out 0x20, al        ; send EOI to PIC
045
046            pop es
047            pop ax
048            iret                ; return from interrupt
049
050 start:      xor ax, ax
051            mov es, ax          ; point es to IVT base
052            mov ax, [es:9*4]
053            mov [oldisr], ax    ; save offset of old routine
054            mov ax, [es:9*4+2]
055            mov [oldisr+2], ax  ; save segment of old routine
056            cli                ; disable interrupts
057            mov word [es:9*4], kbisr ; store offset at n*4
058            mov [es:9*4+2], cs   ; store segment at n*4+2
059            sti                ; enable interrupts
060
061            mov dx, start       ; end of resident portion
062            add dx, 15          ; round up to next para
063            mov cl, 4
064            shr dx, cl          ; number of paras
065            mov ax, 0x3100      ; terminate and stay resident
066            int 0x21

```

When this program is executed the command prompt immediately comes. DIR can be seen. EDIT can run and keypresses do not result in a crash. And with all that left and right shift keys shown L and R on top left of the screen while they are pressed but the shift keys do not work as usual since we did not forward the key to BIOS. This is selective chaining.

To understand Terminate and Stay Resident (TSR) programs the DOS memory formation and allocation procedure must be understood. At physical address zero is the interrupt vector table. Above it are the BIOS data area, DOS data area, IO.SYS, MSDOS.SYS and other device drivers. In the end there is COMMAND.COM command interpreter. The remaining space is called the transient program area as programs are loaded and executed in this area and the space reclaimed on their exit. A freemem pointer in DOS points where the free memory begins. When DOS loads a program the freemem pointer is moved to the end of memory, all the available space is allocated to it, and when it exits the freemem pointer comes back to its original place thereby reclaiming all space. This action is initiated by the DOS service 4C.

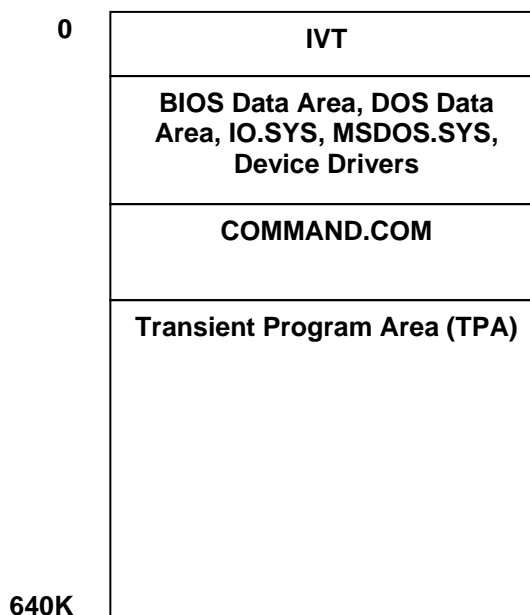

The second method to legally terminate a program and give control back to DOS is using the service 31. Control is still taken back but the memory releasing part is modified. A portion of the allocated memory can be retained. So the difference in the two methods is that the freemem pointer goes back to the original place or a designated number of bytes ahead of that old position. Remember that our program crashed because the interrupt routine was overwritten. If we can tell DOS not to reclaim the memory of the interrupt routine, then it will not crash. In the last program we have told DOS to make a number of bytes resident. It becomes a part of the operation system, an extension to it. Just like DOSKEY[§] is an extension to the operation system.

The number of paragraphs to reserve is given in the DX register. Paragraph is a unit just like byte, word, and double word. A paragraph is 16 bytes. Therefore we can reserve in multiple of 16 bytes. We write TSRs in such a way that the initialization code and data is located at the end as it is not necessary to make it resident and therefore to save space.

To calculate the number of paragraphs a label is placed after the last line that is to be made resident. The value of that label is the number of bytes needed to be made resident. A simple division by 16 will not give the correct number of paras as we want our answer to be rounded up and not down. For example 100 bytes should need 7 pages but division gives 6 and a remainder of 4. A standard technique to get rounded up integer division is to add divisor-1 to the dividend and then divide. So we add 15 to the number of bytes and then divide by 16. We use shifting for division as the divisor is a power of 2. We use a form of SHR that places the count in the CL register so that we can shift by 4 in just two instructions instead of 4 if we shift one by one.

In our program anything after start label is not needed after the program has become a TSR. We can observe that our program has become a part of DOS by giving the following command.

```
mem /c
```

[§] DOSKEY is a TSR that shows the previous commands on the command prompt with up and down arrows and allows editing of the command

This command displays all currently loaded drivers and the current state of memory. We will be able to see our program in the list of DOS drivers.

9.4. PROGRAMMABLE INTERVAL TIMER

Another very important peripheral device is the Programmable Interval Timer (PIT), the chip numbered 8254. This chip has a precise input frequency of 1.19318 MHz. This frequency is fixed regardless of the processor clock. Inside the chip is a 16bit divisor which divides this input frequency and the output is connected to the IRQ 0 line of the PIC. The special number 0 if placed in the divisor means a divisor of 65536 and not 0. The standard divisor is 0 unless we change it. Therefore by default IRQ 0 is generated $1193180/65536=18.2$ times per second. This is called the timer tick. There is an interval of about 55ms between two timer ticks. The system time is maintained with the timer interrupt. This is the highest priority interrupt and breaks whatever is executing. Time can be maintained with this interrupt as this frequency is very precise and is part of the IBM standard.

When writing a TSR we give control back to DOS so TSR activation, reactivation and action is solely interrupt based, whether this is a hardware interrupt or a software one. Control is never given back; it must be caught, just like we caught control by hooking the keyboard interrupt. Our next example will hook the timer interrupt and display a tick count on the screen.

Example 9.7	
001	; display a tick count on the top right of screen
002	[org 0x0100]
003	jmp start
004	
005	tickcount: dw 0
006	
007	; subroutine to print a number at top left of screen
008	; takes the number to be printed as its parameter
009	printnum: push bp
010	mov bp, sp
011	push es
012	push ax
013	push bx
014	push cx
015	push dx
016	push di
017	
018	mov ax, 0xb800
019	mov es, ax ; point es to video base
020	mov ax, [bp+4] ; load number in ax
021	mov bx, 10 ; use base 10 for division
022	mov cx, 0 ; initialize count of digits
023	
024	nextdigit: mov dx, 0 ; zero upper half of dividend
025	div bx ; divide by 10
026	add dl, 0x30 ; convert digit into ascii value
027	push dx ; save ascii value on stack
028	inc cx ; increment count of values
029	cmp ax, 0 ; is the quotient zero
030	jnz nextdigit ; if no divide it again
031	
032	mov di, 140 ; point di to 70th column
033	
034	nextpos: pop dx ; remove a digit from the stack
035	mov dh, 0x07 ; use normal attribute
036	mov [es:di], dx ; print char on screen
037	add di, 2 ; move to next screen location
038	loop nextpos ; repeat for all digits on stack
039	
040	pop di
041	pop dx
042	pop cx
043	pop bx
044	pop ax

```

045             pop  es
046             pop  bp
047             ret  2
048
049             ; timer interrupt service routine
050 timer:      push  ax
051
052             inc  word [cs:tickcount]; increment tick count
053             push word [cs:tickcount]
054             call printnum           ; print tick count
055
056             mov  al, 0x20
057             out  0x20, al           ; end of interrupt
058
059             pop  ax
060             iret                    ; return from interrupt
061
062 start:      xor  ax, ax
063             mov  es, ax             ; point es to IVT base
064             cli                    ; disable interrupts
065             mov  word [es:8*4], timer; store offset at n*4
066             mov  [es:8*4+2], cs     ; store segment at n*4+2
067             sti                    ; enable interrupts
068
069             mov  dx, start           ; end of resident portion
070             add  dx, 15              ; round up to next para
071             mov  cl, 4
072             shr  dx, cl              ; number of paras
073             mov  ax, 0x3100         ; terminate and stay resident
074             int  0x21

```

When we execute the program the counter starts on the screen. Whatever we do, take directory, open EDIT, the debugger etc. the counter remains running on the screen. No one is giving control to the program; the program is getting executed as a result of timer generating INT 8 after every 55ms.

Our next example will hook both the keyboard and timer interrupts. When the shift key is pressed the tick count starts incrementing and as soon as the shift key is released the tick count stops. Both interrupt handlers are communicating through a common variable. The keyboard interrupt sets this variable while the timer interrupts modifies its behavior according to this variable.

Example 9.8

```

001             ; display a tick count while the left shift key is down
002 [org 0x0100]
003             jmp  start
004
005 seconds:    dw  0
006 timerflag: dw  0
007 oldkb:     dd  0
008
009-049      ;;;; COPY LINES 007-047 FROM EXAMPLE 9.7 (printnum) ;;;;
050
051             ; keyboard interrupt service routine
052 kbisr:      push  ax
053
054             in   al, 0x60           ; read char from keyboard port
055             cmp  al, 0x2a           ; has the left shift pressed
056             jne nextcmp            ; no, try next comparison
057
058             cmp  word [cs:timerflag], 1; is the flag already set
059             je  exit               ; yes, leave the ISR
060
061             mov  word [cs:timerflag], 1; set flag to start printing
062             jmp  exit               ; leave the ISR
063
064 nextcmp:    cmp  al, 0xaa           ; has the left shift released
065             jne nomatch            ; no, chain to old ISR
066
067             mov  word [cs:timerflag], 0; reset flag to stop printing

```

```

068             jmp  exit           ; leave the interrupt routine
069
070 nomatch:    pop  ax
071             jmp  far [cs:oldkb]  ; call original ISR
072
073 exit:       mov  al, 0x20
074             out  0x20, al       ; send EOI to PIC
075
076             pop  ax
077             iret                ; return from interrupt
078
079 ; timer interrupt service routine
080 timer:      push ax
081
082             cmp  word [cs:timerflag], 1 ; is the printing flag set
083             jne  skipall        ; no, leave the ISR
084
085             inc  word [cs:seconds] ; increment tick count
086             push word [cs:seconds]
087             call printnum        ; print tick count
088
089 skipall:    mov  al, 0x20
090             out  0x20, al       ; send EOI to PIC
091
092             pop  ax
093             iret                ; return from interrupt
094
095 start:      xor  ax, ax
096             mov  es, ax         ; point es to IVT base
097             mov  ax, [es:9*4]
098             mov  [oldkb], ax    ; save offset of old routine
099             mov  ax, [es:9*4+2]
100            mov  [oldkb+2], ax   ; save segment of old routine
101            cli                    ; disable interrupts
102            mov  word [es:9*4], kbisr ; store offset at n*4
103            mov  word [es:9*4+2], cs ; store segment at n*4+2
104            mov  word [es:8*4], timer ; store offset at n*4
105            mov  [es:8*4+2], cs   ; store segment at n*4+
106            sti                    ; enable interrupts
107
108            mov  dx, start        ; end of resident portion
109            add  dx, 15           ; round up to next para
110            mov  cl, 4
111            shr  dx, cl           ; number of paras
112            mov  ax, 0x3100      ; terminate and stay resident
113            int  0x21

```

006 This flag is one when the timer interrupt should increment and zero when it should not.

058-059 As the keyboard controller repeatedly generates the press code if the release code does not come in a specified time, we have placed a check to not repeatedly set it to one.

058 Another way to access TSR data is using the CS override instead of initializing DS. It is common mistake not to initialize DS and also not put in CS override in a real time interrupt handler.

When we execute the program and the shift key is pressed, the counter starts incrementing. When the key is released the counter stops. When it is pressed again the counter resumes counting. As this is made as a TSR any other program can be loaded and will work properly alongside the TSR.

9.5. PARALLEL PORT

Computers can control external hardware through various external ports like the parallel port, the serial port, and the new additions USB and FireWire. Using this, computers can be used to control almost anything. For our examples we will use the parallel port. The parallel port has two views, the connector that the external world sees and the parallel port controller

ports through which the processor communicates with the device connected to the parallel port.

The parallel port connector is a 25pin connector called DB-25. Different pins of this connector have different meanings. Some are meaningful only with the printer**. This is a bidirectional port so there are some pins to take data from the processor to the parallel port and others to take data from the parallel port to the processor. Important pins for our use are the data pins from pin 2 to pin 9 that take data from the processor to the device. Pin 10, the ACK pin, is normally used by the printer to acknowledge the receipt of data and show the willingness to receive more data. Signaling this pin generates IRQ 7 if enabled in the PIC and in the parallel port controller. Pin 18-25 are ground and must be connected to the external circuit ground to provide the common reference point otherwise they won't understand each other voltage levels. Like the datum point in a graph this is the datum point of an electrical circuit. The remaining pins are not of our concern in these examples.

This is the external view of the parallel port. The processor cannot see these pins. The processor uses the I/O ports of the parallel port controller. The first parallel port LPT1†† has ports designated from 378 to 37A. The first port 378 is the data port. If we use the OUT instruction on this port, 1 bits result in a 5V signal on the corresponding pin and a 0 bits result in a 0V signal on the corresponding pin.

Port 37A is the control port. Our interest is with bit 4 of this port which enables the IRQ 7 triggering by the ACK pin. We have attached a circuit that connects 8 LEDs with the parallel port pins. The following examples sends the scancode of the key pressed to the parallel port so that it is visible on LEDs.

Example 9.9	
001	; show scancode on external LEDs connected through parallel port
002	[org 0x0100]
003	jmp start
004	
005	oldisr: dd 0 ; space for saving old ISR
006	
007	; keyboard interrupt service routine
008	kbisr: push ax
009	push dx
010	
011	in al, 0x60 ; read char from keyboard port
012	mov dx, 0x378
013	out dx, al ; write char to parallel port
014	
015	pop ax
016	pop dx
017	jmp far [cs:oldisr] ; call original ISR
018	
019	start: xor ax, ax
020	mov es, ax ; point es to IVT base
021	mov ax, [es:9*4]
022	mov [oldisr], ax ; save offset of old routine
023	mov ax, [es:9*4+2]
024	mov [oldisr+2], ax ; save segment of old routine
025	cli ; disable interrupts
026	mov word [es:9*4], kbisr ; store offset at n*4
027	mov [es:9*4+2], cs ; store segment at n*4+2
028	sti ; enable interrupts
029	
030	mov dx, start ; end of resident portion
031	add dx, 15 ; round up to next para

** The parallel port is most commonly used with the printer. However some new printers have started using the USB port.

†† Older computer had more than one parallel port named LPT2 and having ports from 278-27A.

```

032         mov  cl, 4
033         shr  dx, cl           ; number of paras
034         mov  ax, 0x3100      ; terminate and stay resident
035         int  0x21

```

The following example uses the same LED circuit and sends data such that LEDs switch on and off turn by turn so that it looks like light is moving back and forth.

Example 9.10	
001	; show lights moving back and forth on external LEDs
002	[org 0x0100]
003	jmp start
004	
005	signal: db 1 ; current state of lights
006	direction: db 0 ; current direction of motion
007	
008	; timer interrupt service routine
009	timer: push ax
010	push dx
011	push ds
012	
013	push cs
014	pop ds ; initialize ds to data segment
015	
016	cmp byte [direction], 1; are moving in right direction
017	je moveright ; yes, go to shift right code
018	
019	shl byte [signal], 1 ; shift left state of lights
020	jnc output ; no jump to change direction
021	
022	mov byte [direction], 1; change direction to right
023	mov byte [signal], 0x80; turn on left most light
024	jmp output ; proceed to send signal
025	
026	moveright: shr byte [signal], 1 ; shift right state of lights
027	jnc output ; no jump to change direction
028	
029	mov byte [direction], 0; change direction to left
030	mov byte [signal], 1 ; turn on right most light
031	
032	output: mov al, [signal] ; load lights state in al
033	mov dx, 0x378 ; parallel port data port
034	out dx, al ; send light state of port
035	
036	mov al, 0x20
037	out 0x20, al ; send EOI on PIC
038	
039	pop ds
040	pop dx
041	pop ax
042	iret ; return from interrupt
043	
044	start: xor ax, ax
045	mov es, ax ; point es to IVT base
046	cli ; disable interrupts
047	mov word [es:8*4], timer; store offset at n*4
048	mov [es:8*4+2], cs ; store segment at n*4+2
049	sti ; enable interrupts
050	
051	mov dx, start ; end of resident portion
052	add dx, 15 ; round up to next para
053	mov cl, 4
054	shr dx, cl ; number of paras
055	mov ax, 0x3100 ; terminate and stay resident
056	int 0x21

We will now use the parallel port to control a slightly complicated circuit. This time we will also use the parallel port interrupt. We are using a 220 V bulb with AC input. AC current is 50Hz sine wave. We have made our circuit such that it triggers the parallel port interrupt whenever the sine wave

crosses zero. We have control of passing the AC current to the bulb. We control it such that in every cycle only a fixed percentage of time the current passes on to the bulb. Using this we can control the intensity or glow of the bulb.

Our first example will slowly turn on the bulb by increasing the power provided using the mechanism just described.

Example 9.11	
001	; slowly turn on a bulb by gradually increasing the power provided
002	[org 0x0100]
003	jmp start
004	
005	flag: db 0 ; next time turn on or turn off
006	stop: db 0 ; flag to terminate the program
007	divider: dw 11000 ; divider for minimum intensity
008	oldtimer: dd 0 ; space for saving old isr
009	
010	; timer interrupt service routine
011	timer: push ax
012	push dx
013	
014	cmp byte [cs:flag], 0 ; are we here to turn off
015	je switchoff ; yes, go to turn off code
016	
017	switchon: mov al, 1
018	mov dx, 0x378
019	out dx, al ; no, turn the bulb on
020	
021	mov ax, 0x0100
022	out 0x40, al ; set timer divisor LSB to 0
023	mov al, ah
024	out 0x40, al ; set timer divisor MSB to 1
025	mov byte [cs:flag], 0 ; flag next timer to switch off
026	jmp exit ; leave the interrupt routine
027	
028	switchoff: xor ax, ax
029	mov dx, 0x378
030	out dx, al ; turn the bulb off
031	
032	exit: mov al, 0x20
033	out 0x20, al ; send EOI to PIC
034	
035	pop dx
036	pop ax
037	iret ; return from interrupt
038	
039	; parallel port interrupt service routine
040	parallel: push ax
041	
042	mov al, 0x30 ; set timer to one shot mode
043	out 0x43, al
044	
045	cmp word [cs:divider], 100; is the current divisor 100
046	je stopit ; yes, stop
047	
048	sub word [cs:divider], 10; decrease the divisor by 10
049	mov ax, [cs:divider]
050	out 0x40, al ; load divisor LSB in timer
051	mov al, ah
052	out 0x40, al ; load divisor MSB in timer
053	mov byte [cs:flag], 1 ; flag next timer to switch on
054	
055	mov al, 0x20
056	out 0x20, al ; send EOI to PIC
057	pop ax
058	iret ; return from interrupt
059	
060	stopit: mov byte [stop], 1 ; flag to terminate the program
061	mov al, 0x20
062	out 0x20, al ; send EOI to PIC
063	pop ax
064	iret ; return from interrupt
065	

```

066      start:      xor  ax, ax
067                mov  es, ax          ; point es to IVT base
068                mov  ax, [es:0x08*4]
069                mov  [oldtimer], ax   ; save offset of old routine
070                mov  ax, [es:0x08*4+2]
071                mov  [oldtimer+2], ax ; save segment of old routine
072                cli                               ; disable interrupts
073                mov  word [es:0x08*4], timer ; store offset at n*4
074                mov  [es:0x08*4+2], cs   ; store segment at n*4+2
075                mov  word [es:0x0F*4], parallel ; store offset at n*4
076                mov  [es:0x0F*4+2], cs   ; store segment at n*4+2
077                sti                               ; enable interrupts
078
079                mov  dx, 0x37A
080                in   al, dx              ; parallel port control register
081                or   al, 0x10           ; turn interrupt enable bit on
082                out  dx, al             ; write back register
083
084                in   al, 0x21           ; read interrupt mask register
085                and  al, 0x7F          ; enable IRQ7 for parallel port
086                out  0x21, al          ; write back register
087
088      recheck:    cmp  byte [stop], 1   ; is the termination flag set
089                jne  recheck           ; no, check again
090
091                mov  dx, 0x37A
092                in   al, dx              ; parallel port control register
093                and  al, 0xEF          ; turn interrupt enable bit off
094                out  dx, al             ; write back register
095
096                in   al, 0x21           ; read interrupt mask register
097                or   al, 0x80          ; disable IRQ7 for parallel port
098                out  0x21, al          ; write back register
099
100                cli                               ; disable interrupts
101                mov  ax, [oldtimer]     ; read old timer ISR offset
102                mov  [es:0x08*4], ax   ; restore old timer ISR offset
103                mov  ax, [oldtimer+2]  ; read old timer ISR segment
104                mov  [es:0x08*4+2], ax ; restore old timer ISR segment
105                sti                               ; enable interrupts
106
107                mov  ax, 0x4c00        ; terminate program
108                int  0x21

```

The next example is simply the opposite of the previous. It slowly turns the bulb off from maximum glow to no glow.

Example 9.12	
001	; slowly turn off a bulb by gradually decreasing the power provided
002	[org 0x0100]
003	jmp start
004	
005	flag: db 0 ; next time turn on or turn off
006	stop: db 0 ; flag to terminate the program
007	divider: dw 0 ; divider for maximum intensity
008	oldtimer: dd 0 ; space for saving old isr
009	
010-037	;;;; COPY LINES 009-036 FROM EXAMPLE 9.11 (timer) ;;;;
038	
039	; parallel port interrupt service routine
040	parallel: push ax
041	
042	mov al, 0x30 ; set timer to one shot mode
043	out 0x43, al
044	
045	cmp word [cs:divider], 11000; current divisor is 11000
046	je stopit ; yes, stop
047	
048	add word [cs:divider], 10; increase the divisor by 10
049	mov ax, [cs:divider]
050	out 0x40, al ; load divisor LSB in timer
051	mov al, ah
052	out 0x40, al ; load divisor MSB in timer

```

053             mov byte [cs:flag], 1 ; flag next timer to switch on
054
055             mov al, 0x20
056             out 0x20, al           ; send EOI to PIC
057             pop ax
058             iret                   ; return from interrupt
059
060 stopit:      mov byte [stop], 1    ; flag to terminate the program
061             mov al, 0x20
062             out 0x20, al           ; send EOI to PIC
063             pop ax
064             iret                   ; return from interrupt
065
066 start:      xor ax, ax
067             mov es, ax              ; point es to IVT base
068             mov ax, [es:0x08*4]
069             mov [oldtimer], ax     ; save offset of old routine
070             mov ax, [es:0x08*4+2]
071             mov [oldtimer+2], ax   ; save segment of old routine
072             cli                    ; disable interrupts
073             mov word [es:0x08*4], timer ; store offset at n*4
074             mov [es:0x08*4+2], cs  ; store segment at n*4+2
075             mov word [es:0x0F*4], parallel ; store offset at n*4
076             mov [es:0x0F*4+2], cs  ; store segment at n*4+2
077             sti                    ; enable interrupts
078
079             mov dx, 0x37A
080             in al, dx               ; parallel port control register
081             or al, 0x10             ; turn interrupt enable bit on
082             out dx, al             ; write back register
083
084             in al, 0x21             ; read interrupt mask register
085             and al, 0x7F           ; enable IRQ7 for parallel port
086             out 0x21, al          ; write back register
087
088 recheck:    cmp byte [stop], 1    ; is the termination flag set
089             jne recheck           ; no, check again
090
091             mov dx, 0x37A
092             in al, dx               ; parallel port control register
093             and al, 0xEF           ; turn interrupt enable bit off
094             out dx, al             ; write back register
095
096             in al, 0x21             ; read interrupt mask register
097             or al, 0x80            ; disable IRQ7 for parallel port
098             out 0x21, al          ; write back register
099
100            cli                    ; disable interrupts
101            mov ax, [oldtimer]      ; read old timer ISR offset
102            mov [es:0x08*4], ax    ; restore old timer ISR offset
103            mov ax, [oldtimer+2]   ; read old timer ISR segment
104            mov [es:0x08*4+2], ax  ; restore old timer ISR segment
105            sti                    ; enable interrupts
106
107            mov ax, 0x4c00         ; terminate program
108            int 0x21

```

This example is a mix of the previous two. Here we can increase the bulb intensity with F11 and decrease it with F12.

Example 9.13	
001	; control external bulb intensity with F11 and F12
002	[org 0x0100]
003	jmp start
004	
005	flag: db 0 ; next time turn on or turn off
006	divider: dw 100 ; initial timer divider
007	oldkb: dd 0 ; space for saving old ISR
008	
009-036	; ; ; ; COPY LINES 009-036 FROM EXAMPLE 9.11 (timer) ; ; ; ;
037	
038	; keyboard interrupt service routine
039	kbisr: push ax

```

040
041         in    al, 0x60
042         cmp   al, 0x57
043         jne   nextcmp
044         cmp   word [cs:divider], 11000
045         je    exitkb
046         add   word [cs:divider], 100
047         jmp   exitkb
048
049 nextcmp:  cmp   al, 0x58
050         jne   chain
051         cmp   word [cs:divider], 100
052         je    exitkb
053         sub   word [cs:divider], 100
054         jmp   exitkb
055
056 exitkb:   mov   al, 0x20
057         out   0x20, al
058
059         pop   ax
060         iret
061
062 chain:    pop   ax
063         jmp   far [cs:oldkb]
064
065 ; parallel port interrupt service routine
066 parallel: push ax
067
068         mov   al, 0x30           ; set timer to one shot mode
069         out   0x43, al
070
071         mov   ax, [cs:divider]
072         out   0x40, al           ; load divisor LSB in timer
073         mov   al, ah
074         out   0x40, al           ; load divisor MSB in timer
075         mov   byte [cs:flag], 1 ; flag next timer to switch on
076
077         mov   al, 0x20
078         out   0x20, al           ; send EOI to PIC
079         pop   ax
080         iret                     ; return from interrupt
081
082 start:    xor   ax, ax
083         mov   es, ax             ; point es to IVT base
084         mov   ax, [es:0x09*4]
085         mov   [oldkb], ax        ; save offset of old routine
086         mov   ax, [es:0x09*4+2]
087         mov   [oldkb+2], ax     ; save segment of old routine
088         cli                     ; disable interrupts
089         mov   word [es:0x08*4], timer ; store offset at n*4
090         mov   [es:0x08*4+2], cs   ; store segment at n*4+2
091         mov   word [es:0x09*4], kbisr ; store offset at n*4
092         mov   [es:0x09*4+2], cs  ; store segment at n*4+2
093         mov   word [es:0x0F*4], parallel ; store offset at n*4
094         mov   [es:0x0F*4+2], cs  ; store segment at n*4+2
095         sti                     ; enable interrupts
096
097         mov   dx, 0x37A
098         in    al, dx             ; parallel port control register
099         or    al, 0x10           ; turn interrupt enable bit on
100        out   dx, al             ; write back register
101
102         in    al, 0x21           ; read interrupt mask register
103         and   al, 0x7F           ; enable IRQ7 for parallel port
104         out   0x21, al           ; write back register
105
106         mov   dx, start          ; end of resident portion
107         add   dx, 15             ; round up to next para
108         mov   cl, 4
109         shr   dx, cl             ; number of paras
110         mov   ax, 0x3100         ; terminate and stay resident
111         int   0x21

```

Computer Architecture & Assembly Language Programming	Course Code: CS401
CS401@vu.edu.pk	VU

EXERCISES

1. Suggest a reason for the following. The statements are all true.
 - a. We should disable interrupts while hooking interrupt 8h. I.e. while placing its segment and offset in the interrupt vector table.
 - b. We need not do this for interrupt 80h.
 - c. We need not do this when hooking interrupt 8h from inside the interrupt handler of interrupt 80h.
 - d. We should disable interrupts while we are changing the stack (SS and SP).
 - e. EOI is not sent from an interrupt handler which does interrupt chaining.
 - f. If no EOI is sent from interrupt 9h and no chaining is done, interrupt 8h still comes if the interrupt flag is on.
 - g. After getting the size in bytes by putting a label at the end of a COM TSR, 0fh is added before dividing by 10h.
 - h. Interrupts are disabled but divide by zero interrupt still comes.
2. If no hardware interrupts are coming, what are all possible reasons?
3. Write a program to make an asterisks travel the border of the screen, from upper left to upper right to lower right to lower left and back to upper left indefinitely, making each movement after one second.
4. [Musical Arrow] Write a TSR to make an arrow travel the border of the screen from top left to top right to bottom right to bottom left and back to top left at the speed of 36.4 locations per second. The arrow should not destroy the data beneath it and should be restored as soon as the arrow moves forward.
The arrow head should point in the direction of movement using the characters > V < and ^. The journey should be accompanied by a different tone from the pc speaker for each side of the screen. Do interrupt chaining so that running the TSR 10 times produces 10 arrows traveling at different locations.
HINT: At the start you will need to reprogram channel 0 for 36.4 interrupts per second, double the normal. You will have to reprogram channel 2 at every direction change, though you can enable the speaker once at the very start.
5. In the above TSR hook the keyboard interrupt as well and check if 'q' is pressed. If not chain to the old interrupt, if yes restore everything and remove the TSR from memory. The effect should be that pressing 'q' removes one moving arrow. If you do interrupt chaining when pressing 'q' as well, it will remove all arrows at once.
6. Write a TSR to rotate the screen (scroll up and copy the old top most line to the bottom) while F10 is pressed. The screen will keep rotating while F10 is pressed at 18.2 rows per second. As soon as F10 is released the rotation should stop and the original screen restored. A secondary buffer of only 160 bytes (one line of screen) can be used.
7. Write a TSR that hooks software interrupt 0x80 and the timer interrupt. The software interrupt is called by other programs with the address of a far function in ES:DI and the number of timer ticks after which to call back that function in CX. The interrupt records this information and returns to the caller. The function will actually be called by the timer interrupt after the desired number of ticks. The maximum number of functions and their ticks can be fixed to 8.
8. Write a TSR to clear the screen when CTRL key is pressed and restore it when it is released.
9. Write a TSR to disable all writes to the hard disk when F10 is pressed and enable when pressed again like a toggle.

Computer Architecture & Assembly Language Programming	Course Code: CS401
CS401@vu.edu.pk	VU

HINT: To write to the hard disk programs call the BIOS service INT 0x13 with AH=3.

10. Write a keyboard interrupt handler that disables the timer interrupt (no timer interrupt should come) while Q is pressed. It should be re-enabled as soon as Q is released.
11. Write a TSR to calculate the current typing speed of the user. Current typing speed is the number of characters typed by the user in the last five seconds. The speed should be represented by printing asterisks at the right border (80th column) of the screen starting from the upper right to the lower right corner (growing downwards). Draw n asterisks if the user typed n characters in the last five seconds. The count should be updated every second.
12. Write a TSR to show a clock in the upper right corner of the screen in the format HH:MM:SS.DD where HH is hours in 24 hour format, MM is minutes, SS is seconds and DD is hundredth of second. The clock should beep twice for one second each time with half a second interval in between at the start of every minute at a frequency of your choice.

HINT: IBM PC uses a Real Time Clock (RTC) chip to keep track of time while switched off. It provides clock and calendar functions through its two I/O ports 70h and 71h. It is used as follows:

```

mov  al, <command>
out  0x70, al      ; command byte written at first port
jmp  D1           ; waste one instruction time
D1:  in  al, 0x71   ; result of command is in AL now

```

Following are few commands

- 00 Get current second
- 02 Get current minute
- 04 Get current hour

All numbers returned by RTC are in BCD. E.g. if it is 6:30 the second and third command will return 0x30 and 0x06 respectively in al.

10

Debug Interrupts

10.1. DEBUGGER USING SINGLE STEP INTERRUPT

The use of the trap flag has been deferred till now. The three flags not used for mathematical operations are the direction flag, the interrupt flag and the trap flag. The direction and interrupt flags have been previously discussed.

If the interrupt flag is set, the after every instruction a type 1 interrupt will be automatically generated. When the IVT and reserved interrupts were discussed this was named as the single step interrupt. This is like the divide by zero interrupt which was never explicitly invoked but it came itself. The single step interrupt behaves in the same manner.

The debugger is made using this interrupt. It allows one instruction to be executed and then return control to us. It has its display code and its code to wait for the key in the INT 1 handler. Therefore after every instruction the values of all registers are shown and the debugger waits for a key. Another interrupt used by the debugger is the breakpoint interrupt INT 3. Apart from single stepping debugger has the breakpoint feature. INT 3 is used for this feature. INT 3 has a single byte opcode so it can replace any instruction. To put a breakpoint the instruction is replaced with INT 3 opcode and restored in the INT 3 handler. The INT 3 opcode is placed again by a single step interrupt that is set up for this purpose after the replaced instruction has been executed.

There is no instruction to set or clear the trap flag like there are instructions for the interrupt and direction flags. We use two special instructions PUSHF and POPF to push and pop the flag from the stack. We use PUSHF to place flags on the stack, change TF in this image on the stack and then reload into the flags register with POPF. The single step interrupt will come after the first instruction after POPF. The interrupt mechanism automatically clears IF and TF otherwise there would an infinite recursion of the single step interrupt. The TF is set in the flags on the stack so another interrupt will comes after one more instruction is executed after the return of the interrupt.

The following example is a very elementary debugger using the trap flag and the single step interrupt.

Example 10.1

```
001 ; single stepping using the trap flag and single step interrupt
002 [org 0x0100]
003         jmp start
004
005 flag:      db 0 ; flag whether a key pressed
006 oldisr:    dd 0 ; space for saving old ISR
007 names:     db 'FL =CS =IP =BP =AX =BX =CX =DX =SI =DI =DS =ES ='
008
009-026 ;;;; COPY LINES 008-025 FROM EXAMPLE 6.2 (clrscr) ;;;;
027
028 ; subroutine to print a number on screen
029 ; takes the row no, column no, and number to be printed as parameters
030 printnum:  push bp
031           mov bp, sp
032           push es
033           push ax
034           push bx
035           push cx
```

```

036         push dx
037         push di
038
039         mov di, 80           ; load di with columns per row
040         mov ax, [bp+8]      ; load ax with row number
041         mul di             ; multiply with columns per row
042         mov di, ax         ; save result in di
043         add di, [bp+6]     ; add column number
044         shl di, 1         ; turn into byte count
045         add di, 8         ; to end of number location
046
047         mov ax, 0xb800
048         mov es, ax        ; point es to video base
049         mov ax, [bp+4]    ; load number in ax
050         mov bx, 16        ; use base 16 for division
051         mov cx, 0        ; initialize count of digits
052
053 nextdigit:  mov dx, 0      ; zero upper half of dividend
054             div bx        ; divide by 10
055             add dl, 0x30   ; convert digit into ascii value
056             cmp dl, 0x39  ; is the digit an alphabet
057             jbe skipalpha ; no, skip addition
058             add dl, 7     ; yes, make in alphabet code
059 skipalpha: mov dh, 0x07  ; attach normal attribute
060             mov [es:di], dx ; print char on screen
061             sub di, 2     ; to previous screen location
062             loop nextdigit ; if no divide it again
063
064         pop di
065         pop dx
066         pop cx
067         pop bx
068         pop ax
069         pop es
070         pop bp
071         ret 6
072
073 ; subroutine to print a string
074 ; takes row no, column no, address of string, and its length
075 ; as parameters
076 printstr:  push bp
077             mov bp, sp
078             push es
079             push ax
080             push bx
081             push cx
082             push dx
083             push si
084             push di
085
086             mov ax, 0xb800
087             mov es, ax        ; point es to video base
088
089             mov di, 80       ; load di with columns per row
090             mov ax, [bp+8]    ; load ax with row number
091             mul di           ; multiply with columns per row
092             mov di, ax       ; save result in di
093             add di, [bp+6]    ; add column number
094             shl di, 1        ; turn into byte count
095
096             mov si, [bp+6]    ; string to be printed
097             mov cx, [bp+4]    ; length of string
098             mov ah, 0x07     ; normal attribute is fixed
099
100 nextchar:  mov al, [si]      ; load next char of string
101             mov [es:di], ax   ; show next char on screen
102             add di, 2         ; move to next screen location
103             add si, 1         ; move to next char
104             loop nextchar    ; repeat the operation cx times
105
106         pop di
107         pop si
108         pop dx
109         pop cx
110         pop bx
111         pop ax

```

```

112             pop  es
113             pop  bp
114             ret   8
115
116             ; keyboard interrupt service routine
117 kbisr:      push  ax
118
119             in   al, 0x60           ; read a char from keyboard port
120             test al, 0x80          ; is it a press code
121             jnz  skipflag         ; no, leave the interrupt
122             add  byte [cs:flag], al ; yes, set flag to proceed
123
124
125 skipflag:   mov   al, 0x20
126             out  0x20, al
127             pop  ax
128             iret
129
130             ; single step interrupt service routine
131 trapisr:    push  bp
132             mov  bp, sp           ; to read cs, ip and flags
133             push ax
134             push bx
135             push cx
136             push dx
137             push si
138             push di
139             push ds
140             push es
141
142             sti                    ; waiting for keyboard interrupt
143             push cs
144             pop  ds              ; initialize ds to data segment
145
146             mov  byte [flag], 0   ; set flag to wait for key
147             call clrscr           ; clear the screen
148
149             mov  si, 6             ; first register is at bp+6
150             mov  cx, 12           ; total 12 registers to print
151             mov  ax, 0             ; start from row 0
152             mov  bx, 5             ; print at column 5
153
154 13:         push  ax              ; row number
155             push  bx              ; column number
156             mov  dx, [bp+si]
157             push  dx              ; number to be printed
158             call printnum         ; print the number
159             sub  si, 2            ; point to next register
160             inc  ax               ; next row number
161             loop 13              ; repeat for the 12 registers
162
163             mov  ax, 0            ; start from row 0
164             mov  bx, 0            ; start from column 0
165             mov  cx, 12           ; total 12 register names
166             mov  si, 4            ; each name length is 4 chars
167             mov  dx, names        ; offset of first name in dx
168
169 11:         push  ax              ; row number
170             push  bx              ; column number
171             push  dx              ; offset of string
172             push  si              ; length of string
173             call printstr         ; print the string
174             add  dx, 4            ; point to start of next string
175             inc  ax               ; new row number
176             loop 11              ; repeat for 12 register names
177
178 keywait:   cmp   byte [flag], 0   ; has a key been pressed
179             je   keywait         ; no, check again
180
181             pop  es
182             pop  ds
183             pop  di
184             pop  si
185             pop  dx
186             pop  cx
187             pop  bx
188             pop  ax

```

```

189             pop bp
190             iret
191
192 start:      xor ax, ax
193             mov es, ax             ; point es to IVT base
194             mov ax, [es:9*4]
195             mov [oldisr], ax      ; save offset of old routine
196             mov ax, [es:9*4+2]
197             mov [oldisr+2], ax    ; save segment of old routine
198             mov word [es:1*4], trapisr ; store offset at n*4
199             mov [es:1*4+2], cs    ; store segment at n*4+2
200             cli                   ; disable interrupts
201             mov word [es:9*4], kbisr ; store offset at n*4
202             mov [es:9*4+2], cs    ; store segment at n*4+2
203             sti                   ; enable interrupts
204
205             pushf                  ; save flags on stack
206             pop ax                 ; copy flags in ax
207             or ax, 0x100          ; set bit corresponding to TF
208             push ax                ; save ax on stack
209             popf                   ; reload into flags register
210
211             ; the trap flag bit is on now, INT 1 will come after next instruction
212             ; sample code to check the working of our elementary debugger
213             mov ax, 0
214             mov bx, 0x10
215             mov cx, 0x20
216             mov dx, 0x40
217
218 12:         inc ax
219             add bx, 2
220             dec cx
221             sub dx, 2
222             jmp 12

```

10.2. DEBUGGER USING BREAKPOINT INTERRUPT

We now write a debugger using INT 3. This debugger stops at the same point every time where the breakpoint has been set up unlike the previous one which stopped at every instruction. The single step interrupt in this example is used only to restore the breakpoint interrupt which was removed by the breakpoint interrupt handler temporarily so that the original instruction can be executed.

Example 10.2	
001	; elementary debugger using breakpoint interrupt
002	[org 0x0100]
003	jmp start
004	
005	flag: db 0 ; flag whether a key pressed
006	oldisr: dd 0 ; space for saving old ISR
007	names: db 'FL =CS =IP =BP =AX =BX =CX =DX =SI =DI =DS =ES ='
008	opcode: db 0
009	opcodepos: dw 0
010	
011-028	;;;; COPY LINES 008-025 FROM EXAMPLE 6.2 (clrscr) ;;;;
029-072	;;;; COPY LINES 028-071 FROM EXAMPLE 10.1 (printnum) ;;;;
073-114	;;;; COPY LINES 073-114 FROM EXAMPLE 10.1 (printstr) ;;;;
115-127	;;;; COPY LINES 116-128 FROM EXAMPLE 10.1 (kbisr) ;;;;
128	
129	; single step interrupt service routine
130	trapisr: push bp
131	mov bp, sp
132	push ax
133	push di
134	push ds
135	push es
136	
137	push cs
138	pop ds ; initialize ds to data segment

```

139
140         mov ax, [bp+4]
141         mov es, ax           ; load interrupted segment in es
142         mov di, [opcodepos] ; load saved opcode position
143         mov byte [es:di], 0xCC ; reset the opcode to INT3
144         and word [bp+6], 0xFEFF ; clear TF in flags on stack
145
146         pop es
147         pop ds
148         pop di
149         pop ax
150         pop bp
151         iret
152
153         ; breakpoint interrupt service routine
154 debugisr: push bp
155         mov bp, sp           ; to read cs, ip and flags
156         push ax
157         push bx
158         push cx
159         push dx
160         push si
161         push di
162         push ds
163         push es
164
165         sti                 ; waiting for keyboard interrupt
166         push cs
167         pop ds              ; initialize ds to data segment
168
169         mov ax, [bp+4]
170         mov es, ax           ; load interrupted segment in es
171         dec word [bp+2]      ; decrement the return address
172         mov di, [bp+2]      ; read the return address in di
173         mov word [opcodepos], di ; remember the return position
174         mov al, [opcode]    ; load the original opcode
175         mov [es:di], al     ; restore original opcode there
176
177         mov byte [flag], 0  ; set flag to wait for key
178         call clrscr         ; clear the screen
179
180         mov si, 6           ; first register is at bp+6
181         mov cx, 12          ; total 12 registers to print
182         mov ax, 0           ; start from row 0
183         mov bx, 5           ; print at column 5
184
185 13:      push ax             ; row number
186         push bx             ; column number
187         mov dx, [bp+si]
188         push dx             ; number to be printed
189         call printnum       ; print the number
190         sub si, 2           ; point to next register
191         inc ax              ; next row number
192         loop 13            ; repeat for the 12 registers
193
194         mov ax, 0           ; start from row 0
195         mov bx, 0           ; start from column 0
196         mov cx, 12          ; total 12 register names
197         mov si, 4           ; each name length is 4 chars
198         mov dx, names       ; offset of first name in dx
199
200 11:      push ax             ; row number
201         push bx             ; column number
202         push dx             ; offset of string
203         push si             ; length of string
204         call printstr       ; print the string
205         add dx, 4           ; point to start of next string
206         inc ax              ; new row number
207         loop 11            ; repeat for 12 register names
208
209         or word [bp+6], 0x0100 ; set TF in flags image on stack
210
211 keywait: cmp byte [flag], 0  ; has a key been pressed
212         je keywait         ; no, check again
213
214         pop es

```

```

215         pop ds
216         pop di
217         pop si
218         pop dx
219         pop cx
220         pop bx
221         pop ax
222         pop bp
223         iret
224
225 start:   xor  ax, ax
226         mov  es, ax           ; point es to IVT base
227         mov  word [es:1*4], trapisr ; store offset at n*4
228         mov  [es:1*4+2], cs     ; store segment at n*4+2
229         mov  word [es:3*4], debugisr ; store offset at n*4
230         mov  [es:3*4+2], cs     ; store segment at n*4+2
231         cli                    ; disable interrupts
232         mov  word [es:9*4], kbisr ; store offset at n*4
233         mov  [es:9*4+2], cs     ; store segment at n*4+2
234         sti                    ; enable interrupts
235
236         mov  si, 12           ; load breakpoint position in si
237         mov  al, [cs:si]      ; read opcode at that position
238         mov  [opcode], al     ; save opcode for later use
239         mov  byte [cs:si], 0xCC ; change opcode to INT3
240
241         ; breakpoint is set now, INT3 will come at 12 on every iteration
242         ; sample code to check the working of our elementary debugger
243         mov  ax, 0
244         mov  bx, 0x10
245         mov  cx, 0x20
246         mov  dx, 0x40
247
248 12:     inc  ax
249         add  bx, 2
250         dec  cx
251         sub  dx, 2
252         jmp  12

```

11

Multitasking

11.1. CONCEPTS OF MULTITASKING

To experience the power of assembly language we introduce how to implement multitasking. We observed in the debugger that our thread of instructions was broken by the debugger; it got the control, used all registers, displayed an elaborate interface, waited for the key, and then restored processor state to what was immediately before interruption. Our program resumed as if nothing happened. The program execution was in the same logical flow.

If we have two different programs A and B. Program A is broken, its state saved, and returned to B instead of A. By looking at the instruction set, we can immediately say that nothing can stop us from doing that. IRET will return to whatever CS and IP it finds on the stack. Now B is interrupted somehow, its state saved, and we return back to A. A will have no way of knowing that it was interrupted as its entire environment has been restored. It never knew the debugger took control when it was debugged. It still has no way of gaining this knowledge. If this work of breaking and restoring programs is done at high speed the user will feel that all the programs are running at the same time where actually they are being switched to and forth at high speed.

In essence multitasking is simple, even though we have to be extremely careful when implementing it. The environment of a program in the very simple case is all its registers and stack. We will deal with stack later. Now to get control from the program without the program knowing about it, we can use the IRQ 0 highest priority interrupt that is periodically coming to the processor.

Now we present a very basic example of multitasking. We have two subroutines written in assembly language. All the techniques discussed here are applicable to code written in higher level languages as well. However the code to control this multitasking cannot be easily written in a higher level language so we write it in assembly language. The two subroutines rotate bars by changing characters at the two corners of the screen and have infinite loops. By hooking the timer interrupt and saving and restoring the registers of the tasks one by one, it appears that both tasks are running simultaneously.

Example 11.1

```
001 ; elementary multitasking of two threads
002 [org 0x0100]
003         jmp start
004
005         ; ax,bx,ip,cs,flags storage area
006 taskstates: dw 0, 0, 0, 0, 0 ; task0 regs
007             dw 0, 0, 0, 0, 0 ; task1 regs
008             dw 0, 0, 0, 0, 0 ; task2 regs
009
010 current: db 0 ; index of current task
011 chars:   db '\|/-' ; shapes to form a bar
012
013 ; one task to be multitasked
014 taskone: mov al, [chars+bx] ; read the next shape
015         mov [es:0], al ; write at top left of screen
```

```

016             inc  bx             ; increment to next shape
017             and  bx, 3          ; taking modulus by 4
018             jmp  taskone       ; infinite task
019
020 ; second task to be multitasked
021 tasktwo:    mov  al, [chars+bx]  ; read the next shape
022             mov  [es:158], al    ; write at top right of screen
023             inc  bx             ; increment to next shape
024             and  bx, 3          ; taking modulus by 4
025             jmp  tasktwo       ; infinite task
026
027 ; timer interrupt service routine
028 timer:     push ax
029             push bx
030
031             mov  bl, [cs:current] ; read index of current task
032             mov  ax, 10          ; space used by one task
033             mul  bl             ; multiply to get start of task
034             mov  bx, ax         ; load start of task in bx
035
036             pop  ax             ; read original value of bx
037             mov  [cs:taskstates+bx+2], ax ; space for current task
038             pop  ax             ; read original value of ax
039             mov  [cs:taskstates+bx+0], ax ; space for current task
040             pop  ax             ; read original value of ip
041             mov  [cs:taskstates+bx+4], ax ; space for current task
042             pop  ax             ; read original value of cs
043             mov  [cs:taskstates+bx+6], ax ; space for current task
044             pop  ax             ; read original value of flags
045             mov  [cs:taskstates+bx+8], ax ; space for current task
046
047             inc  byte [cs:current] ; update current task index
048             cmp  byte [cs:current], 3 ; is task index out of range
049             jne  skipreset      ; no, proceed
050             mov  byte [cs:current], 0 ; yes, reset to task 0
051
052 skipreset:  mov  bl, [cs:current] ; read index of current task
053             mov  ax, 10          ; space used by one task
054             mul  bl             ; multiply to get start of task
055             mov  bx, ax         ; load start of task in bx
056
057             mov  al, 0x20
058             out  0x20, al       ; send EOI to PIC
059
060             push word [cs:taskstates+bx+8] ; flags of new task
061             push word [cs:taskstates+bx+6] ; cs of new task
062             push word [cs:taskstates+bx+4] ; ip of new task
063             mov  ax, [cs:taskstates+bx+0] ; ax of new task
064             mov  bx, [cs:taskstates+bx+2] ; bx of new task
065             iret                ; return to new task
066
067 start:     mov  word [taskstates+10+4], taskone ; initialize ip
068             mov  [taskstates+10+6], cs      ; initialize cs
069             mov  word [taskstates+10+8], 0x0200 ; initialize flags
070             mov  word [taskstates+20+4], tasktwo ; initialize ip
071             mov  [taskstates+20+6], cs      ; initialize cs
072             mov  word [taskstates+20+8], 0x0200 ; initialize flags
073             mov  word [current], 0         ; set current task index
074
075             xor  ax, ax
076             mov  es, ax                ; point es to IVT base
077             cli
078             mov  word [es:8*4], timer
079             mov  [es:8*4+2], cs        ; hook timer interrupt
080             mov  ax, 0xb800
081             mov  es, ax                ; point es to video base
082             xor  bx, bx                ; initialize bx for tasks
083             sti
084
085             jmp  $                    ; infinite loop

```

The space where all registers of a task are stored is called the process control block or PCB. Actual PCB contains a few more things that are not

relevant to us now. INT 08 that is saving and restoring the registers is called the scheduler and the whole event is called a context switch.

11.2. ELABORATE MULTITASKING

In our next example we will save all 14 registers and the stack as well. 28 bytes are needed by these registers in the PCB. We add some more space to make the size 32, a power of 2 for easy calculations. One of these words is used to form a linked list of the PCBs so that strict ordering of active PCBs is not necessary. Also in this example we have given every thread its own stack. Now threads can have function calls, parameters and local variables etc. Another important change in this example is that the creation of threads is now dynamic. The thread registration code initializes the PCB, and adds it to the linked list so that the scheduler will give it a turn.

Example 11.2	
001	; multitasking and dynamic thread registration
002	[org 0x0100]
003	jmp start
004	
005	; PCB layout:
006	; ax,bx,cx,dx,si,di,bp,sp,ip,cs,ds,ss,es,flags,next,dummy
007	; 0, 2, 4, 6, 8,10,12,14,16,18,20,22,24, 26 , 28 , 30
008	
009	pcb: times 32*16 dw 0 ; space for 32 PCBs
010	stack: times 32*256 dw 0 ; space for 32 512 byte stacks
011	nextpcb: dw 1 ; index of next free pcb
012	current: dw 0 ; index of current pcb
013	lineno: dw 0 ; line number for next thread
014-057	
058	;;;; COPY LINES 028-071 FROM EXAMPLE 10.1 (printnum) ;;;;
059	
060	; mytask subroutine to be run as a thread
061	; takes line number as parameter
062	mytask: push bp
063	mov bp, sp
064	sub sp, 2 ; thread local variable
065	push ax
066	push bx
067	
068	mov ax, [bp+4] ; load line number parameter
069	mov bx, 70 ; use column number 70
070	mov word [bp-2], 0 ; initialize local variable
071	
072	printagain: push ax ; line number
073	push bx ; column number
074	push word [bp-2] ; number to be printed
075	call printnum ; print the number
076	inc word [bp-2] ; increment the local variable
077	jmp printagain ; infinitely print
078	
079	pop bx
080	pop ax
081	mov sp, bp
082	pop bp
083	ret
084	
085	; subroutine to register a new thread
086	; takes the segment, offset, of the thread routine and a parameter
087	; for the target thread subroutine
088	initpcb: push bp
089	mov bp, sp
090	push ax
091	push bx
092	push cx
093	push si
094	
095	mov bx, [nextpcb] ; read next available pcb index
096	cmp bx, 32 ; are all PCBs used
097	je exit ; yes, exit
098	

```

099         mov     cl, 5
100         shl     bx, cl           ; multiply by 32 for pcb start
101
102         mov     ax, [bp+8]       ; read segment parameter
103         mov     [pcb+bx+18], ax  ; save in pcb space for cs
104         mov     ax, [bp+6]       ; read offset parameter
105         mov     [pcb+bx+16], ax  ; save in pcb space for ip
106
107         mov     [pcb+bx+22], ds  ; set stack to our segment
108         mov     si, [nextpcb]    ; read this pcb index
109         mov     cl, 9
110         shl     si, cl           ; multiply by 512
111         add     si, 256*2+stack  ; end of stack for this thread
112         mov     ax, [bp+4]       ; read parameter for subroutine
113         sub     si, 2            ; decrement thread stack pointer
114         mov     [si], ax         ; pushing param on thread stack
115         sub     si, 2            ; space for return address
116         mov     [pcb+bx+14], si  ; save si in pcb space for sp
117
118         mov     word [pcb+bx+26], 0x0200 ; initialize thread flags
119         mov     ax, [pcb+28]     ; read next of 0th thread in ax
120         mov     [pcb+bx+28], ax  ; set as next of new thread
121         mov     ax, [nextpcb]    ; read new thread index
122         mov     [pcb+28], ax     ; set as next of 0th thread
123         inc     word [nextpcb]   ; this pcb is now used
124
125
126     exit:     pop     si
127             pop     cx
128             pop     bx
129             pop     ax
130             pop     bp
131             ret     6
132
133     ; timer interrupt service routine
134     timer:   push    ds
135             push    bx
136
137             push    cs
138             pop     ds           ; initialize ds to data segment
139
140             mov     bx, [current] ; read index of current in bx
141             shl     bx, 1
142             shl     bx, 1
143             shl     bx, 1
144             shl     bx, 1
145             shl     bx, 1       ; multiply by 32 for pcb start
146             mov     [pcb+bx+0], ax ; save ax in current pcb
147             mov     [pcb+bx+4], cx ; save cx in current pcb
148             mov     [pcb+bx+6], dx ; save dx in current pcb
149             mov     [pcb+bx+8], si ; save si in current pcb
150             mov     [pcb+bx+10], di ; save di in current pcb
151             mov     [pcb+bx+12], bp ; save bp in current pcb
152             mov     [pcb+bx+24], es ; save es in current pcb
153
154             pop     ax           ; read original bx from stack
155             mov     [pcb+bx+2], ax ; save bx in current pcb
156             pop     ax           ; read original ds from stack
157             mov     [pcb+bx+20], ax ; save ds in current pcb
158             pop     ax           ; read original ip from stack
159             mov     [pcb+bx+16], ax ; save ip in current pcb
160             pop     ax           ; read original cs from stack
161             mov     [pcb+bx+18], ax ; save cs in current pcb
162             pop     ax           ; read original flags from stack
163             mov     [pcb+bx+26], ax ; save cs in current pcb
164             mov     [pcb+bx+22], ss ; save ss in current pcb
165             mov     [pcb+bx+14], sp ; save sp in current pcb
166
167             mov     bx, [pcb+bx+28] ; read next pcb of this pcb
168             mov     [current], bx   ; update current to new pcb
169             mov     cl, 5
170             shl     bx, cl           ; multiply by 32 for pcb start
171
172             mov     cx, [pcb+bx+4] ; read cx of new process
173             mov     dx, [pcb+bx+6] ; read dx of new process
174             mov     si, [pcb+bx+8] ; read si of new process
175             mov     di, [pcb+bx+10] ; read diof new process

```

```

176         mov bp, [pcb+bx+12]    ; read bp of new process
177         mov es, [pcb+bx+24]    ; read es of new process
178         mov ss, [pcb+bx+22]    ; read ss of new process
179         mov sp, [pcb+bx+14]    ; read sp of new process
180
181         push word [pcb+bx+26]   ; push flags of new process
182         push word [pcb+bx+18]   ; push cs of new process
183         push word [pcb+bx+16]   ; push ip of new process
184         push word [pcb+bx+20]   ; push ds of new process
185
186         mov al, 0x20
187         out 0x20, al           ; send EOI to PIC
188
189         mov ax, [pcb+bx+0]      ; read ax of new process
190         mov bx, [pcb+bx+2]      ; read bx of new process
191         pop ds                  ; read ds of new process
192         iret                   ; return to new process
193
194     start:    xor ax, ax
195             mov es, ax         ; point es to IVT base
196
197             cli
198             mov word [es:8*4], timer
199             mov [es:8*4+2], cs ; hook timer interrupt
200             sti
201
202     nextkey:  xor ah, ah        ; service 0 - get keystroke
203             int 0x16          ; bios keyboard services
204
205             push cs           ; use current code segment
206             mov ax, mytask
207             push ax           ; use mytask as offset
208             push word [lineno] ; thread parameter
209             call initpcb      ; register the thread
210
211             inc word [lineno] ; update line number
212             jmp nextkey       ; wait for next keypress

```

When the program is executed the threads display the numbers independently. However as keys are pressed and new threads are registered, there is an obvious slowdown in the speed of multitasking. To improve that, we can change the timer interrupt frequency. The following can be used to set to an approximately 1ms interval.

```

mov ax, 1100
out 0x40, al
mov al, ah
out 0x40, al

```

This makes the threads look faster. However the only real change is that the timer interrupt is now coming more frequently.

11.3. MULTITASKING KERNEL AS TSR

The above examples had the multitasking code and the multithreaded code in one program. Now we separate the multitasking kernel into a TSR so that it becomes an operation system extension. We hook a software interrupt for the purpose of registering a new thread.

Example 11.3	
001	; multitasking kernel as a TSR
002	[org 0x0100]
003	jmp start
004	
005	; PCB layout:
006	; ax,bx,cx,dx,si,di,bp,sp,ip,cs,ds,ss,es,flags,next,dummy
007	; 0, 2, 4, 6, 8,10,12,14,16,18,20,22,24, 26, 28, 30
008	
009	pcb: times 32*16 dw 0 ; space for 32 PCBs

```

010      stack:      times 32*256 dw 0          ; space for 32 512 byte stacks
011      nextpcb:   dw 1                      ; index of next free pcb
012      current:   dw 0                      ; index of current pcb
013
014-073 ;;;; COPY LINES 133-192 FROM EXAMPLE 11.2 (timer) ;;;;
074
075      ; software interrupt to register a new thread
076      ; takes parameter block in ds:si
077      ; parameter block has cs, ip, ds, es, and param in this order
078      initpcb:    push ax
079                      push bx
080                      push cx
081                      push di
082
083                      mov bx, [cs:nextpcb]   ; read next available pcb index
084                      cmp bx, 32            ; are all PCBs used
085                      je exit              ; yes, exit
086
087                      mov cl, 5
088                      shl bx, cl           ; multiply by 32 for pcb start
089
090                      mov ax, [si+0]        ; read code segment parameter
091                      mov [cs:pcb+bx+18], ax ; save in pcb space for cs
092                      mov ax, [si+2]        ; read offset parameter
093                      mov [cs:pcb+bx+16], ax ; save in pcb space for ip
094                      mov ax, [si+4]        ; read data segment parameter
095                      mov [cs:pcb+bx+20], ax ; save in pcb space for ds
096                      mov ax, [si+6]        ; read extra segment parameter
097                      mov [cs:pcb+bx+24], ax ; save in pcb space for es
098
099                      mov [cs:pcb+bx+22], cs ; set stack to our segment
100                      mov di, [cs:nextpcb]  ; read this pcb index
101                      mov cl, 9
102                      shl di, cl           ; multiply by 512
103                      add di, 256*2+stack  ; end of stack for this thread
104                      mov ax, [si+8]        ; read parameter for subroutine
105                      sub di, 2            ; decrement thread stack pointer
106                      mov [cs:di], ax      ; pushing param on thread stack
107                      sub di, 4            ; space for far return address
108                      mov [cs:pcb+bx+14], di ; save di in pcb space for sp
109
110                      mov word [cs:pcb+bx+26], 0x0200 ; initialize flags
111                      mov ax, [cs:pcb+28]   ; read next of 0th thread in ax
112                      mov [cs:pcb+bx+28], ax ; set as next of new thread
113                      mov ax, [cs:nextpcb]  ; read new thread index
114                      mov [cs:pcb+28], ax  ; set as next of 0th thread
115                      inc word [cs:nextpcb] ; this pcb is now used
116
117      exit:      pop di
118                      pop cx
119                      pop bx
120                      pop ax
121                      iret
122
123
124      start:     xor ax, ax
125                      mov es, ax           ; point es to IVT base
126
127                      mov word [es:0x80*4], initpcb
128                      mov [es:0x80*4+2], cs ; hook software int 80
129                      cli
130                      mov word [es:0x08*4], timer
131                      mov [es:0x08*4+2], cs ; hook timer interrupt
132                      sti
133
134                      mov dx, start
135                      add dx, 15
136                      mov cl, 4
137                      shr dx, cl
138
139                      mov ax, 0x3100      ; terminate and stay resident
140                      int 0x21

```

The second part of our example is a simple program that has the threads to be registered with the multitasking kernel using its exported services.

Example 11.4

```

001 ; multitasking TSR caller
002 [org 0x0100]
003     jmp start
004
005 ; parameter block layout:
006 ; cs,ip,ds,es,param
007 ; 0, 2, 4, 6, 8
008
009 paramblock:  times 5 dw 0           ; space for parameters
010 lineno:    dw 0                   ; line number for next thread
011
012-055 ;;;; COPY LINES 028-071 FROM EXAMPLE 10.1 (printnum) ;;;;
056
057 ; subroutine to be run as a thread
058 ; takes line number as parameter
059 mytask:    push bp
060            mov  bp, sp
061            sub  sp, 2               ; thread local variable
062            push ax
063            push bx
064
065            mov  ax, [bp+4]         ; load line number parameter
066            mov  bx, 70             ; use column number 70
067            mov  word [bp-2], 0     ; initialize local variable
068
069 printagain: push ax                ; line number
070            push bx                 ; column number
071            push word [bp-2]        ; number to be printed
072            call printnum           ; print the number
073            inc  word [bp-2]        ; increment the local variable
074            jmp  printagain         ; infinitely print
075
076            pop  bx
077            pop  ax
078            mov  sp, bp
079            pop  bp
080            retf
081
082 start:     mov  ah, 0               ; service 0 - get keystroke
083            int  0x16              ; bios keyboard services
084
085            mov  [paramblock+0], cs ; code segment parameter
086            mov  word [paramblock+2], mytask ; offset parameter
087            mov  [paramblock+4], ds ; data segment parameter
088            mov  [paramblock+6], es ; extra segment parameter
089            mov  ax, [lineno]
090            mov  [paramblock+8], ax ; parameter for thread
091            mov  si, paramblock     ; address of param block in si
092            int  0x80               ; multitasking kernel interrupt
093
094            inc  word [lineno]      ; update line number
095            jmp  start              ; wait for next key
    
```

We introduce yet another use of the multitasking kernel with this new example. In this example three different sort of routines are multitasked by the same kernel instead of repeatedly registering the same routine.

Example 11.5

```

001 ; another multitasking TSR caller
002 [org 0x0100]
003     jmp start
004
005 ; parameter block layout:
006 ; cs,ip,ds,es,param
007 ; 0, 2, 4, 6, 8
008
009 paramblock:  times 5 dw 0           ; space for parameters
010 lineno:    dw 0                   ; line number for next thread
011 chars:     db  '\|/-'             ; chracters for rotating bar
012 message:   db  'moving hello'     ; moving string
013 message2:  db  ' '                ; to erase previous string
    
```

```

014      messagelen:   dw 12                ; length of above strings
015
016-059  ;;;; COPY LINES 028-071 FROM EXAMPLE 10.1 (printnum) ;;;;
060-101  ;;;; COPY LINES 073-114 FROM EXAMPLE 10.1 (printstr) ;;;;
102
103      ; subroutine to run as first thread
104      mytask:      push bp
105                      mov bp, sp
106                      sub sp, 2          ; thread local variable
107                      push ax
108                      push bx
109
110                      xor ax, ax         ; use line number 0
111                      mov bx, 70         ; use column number 70
112                      mov word [bp-2], 0 ; initialize local variable
113
114      printagain:  push ax               ; line number
115                      push bx           ; column number
116                      push word [bp-2]  ; number to be printed
117                      call printnum     ; print the number
118                      inc word [bp-2]   ; increment the local variable
119                      jmp printagain    ; infinitely print
120
121                      pop bx
122                      pop ax
123                      mov sp, bp
124                      pop bp
125                      retf
126
127
128      ; subroutine to run as second thread
129      mytask2:     push ax
130                      push bx
131                      push es
132
133                      mov ax, 0xb800
134                      mov es, ax        ; point es to video base
135                      xor bx, bx        ; initialize to use first shape
136
137      rotateagain: mov al, [chars+bx]   ; read current shape
138                      mov [es:40], al   ; print at specified place
139                      inc bx             ; update to next shape
140                      and bx, 3         ; take modulus with 4
141                      jmp rotateagain   ; repeat infinitely
142
143                      pop es
144                      pop bx
145                      pop ax
146                      retf
147
148      ; subroutine to run as third thread
149      mytask3:     push bp
150                      mov bp, sp
151                      sub sp, 2          ; thread local variable
152                      push ax
153                      push bx
154                      push cx
155
156                      mov word [bp-2], 0 ; initialize line number to 0
157
158      nextline:    push word [bp-2]     ; line number
159                      mov bx, 50
160                      push bx           ; column number 50
161                      mov ax, message
162                      push ax           ; offset of string
163                      push word [messagelen] ; length of string
164                      call printstr    ; print the string
165
166      waithere:    mov cx, 0x100
167                      push cx           ; save outer loop counter
168                      mov cx, 0xffff
169                      loop $            ; repeat ffff times
170                      pop cx           ; restore outer loop counter
171                      loop waithere    ; repeat 0x100 times
172
173                      push word [bp-2]  ; line number
174                      mov bx, 50        ; column number 50

```

```

175         push bx
176         mov ax, message2
177         push ax           ; offset of blank string
178         push word [messagelen] ; length of string
179         call printstr    ; print the string
180
181         inc word [bp-2]   ; update line number
182         cmp word [bp-2], 25 ; is this the last line
183         jne skipreset    ; no, proceed to draw
184         mov word [bp-2], 0 ; yes, reset line number to 0
185
186 skipreset: jmp nextline    ; proceed with next drawing
187
188         pop cx
189         pop bx
190         pop ax
191         mov sp, bp
192         pop bp
193         retf
194
195 start:   mov [paramblock+0], cs ; code segment parameter
196         mov word [paramblock+2], mytask ; offset parameter
197         mov [paramblock+4], ds ; data segment parameter
198         mov [paramblock+6], es ; extra segment parameter
199         mov word [paramblock+8], 0 ; parameter for thread
200         mov si, paramblock    ; address of param block in si
201         int 0x80              ; multitasking kernel interrupt
202
203         mov [paramblock+0], cs ; code segment parameter
204         mov word [paramblock+2], mytask2 ; offset parameter
205         mov [paramblock+4], ds ; data segment parameter
206         mov [paramblock+6], es ; extra segment parameter
207         mov word [paramblock+8], 0 ; parameter for thread
208         mov si, paramblock    ; address of param block in si
209         int 0x80              ; multitasking kernel interrupt
210
211         mov [paramblock+0], cs ; code segment parameter
212         mov word [paramblock+2], mytask3 ; offset parameter
213         mov [paramblock+4], ds ; data segment parameter
214         mov [paramblock+6], es ; extra segment parameter
215         mov word [paramblock+8], 0 ; parameter for thread
216         mov si, paramblock    ; address of param block in si
217         int 0x80              ; multitasking kernel interrupt
218
219         jmp $

```

EXERCISES

1. Change the multitasking kernel such that a new two byte variable is introduced in the PCB. This variable contains the number of turns this process should be given. For example if the first PCB contains 20 in this variable, the switch to second process should occur after 20 timer interrupts (approx one second at default speed) and similarly the switch from second to third process should occur after the number given in the second process's PCB.
2. Change the scheduler of the multitasking kernel to enqueue the current process index a ready queue, and dequeue the next process index from it, and assign it to current. Therefore the next field of the PCB is no longer used. Use queue functions from Exercise 5.XX.
3. Add a function in the multitasking kernel to fork the current process through a software interrupt. Fork should allocate a new PCB and copy values of all registers of the caller's PCB to the new PCB. It should allocate a stack and change SS, SP appropriately in the new PCB. It has to copy the caller's stack on the newly allocated stack. It will set AX in the new PCB to 0 and in the old PB to 1 so that both threads can identify which is the creator and which is the created process and can act accordingly.

Computer Architecture & Assembly Language Programming	Course Code: CS401
CS401@vu.edu.pk	VU

4. Add a function in the multitasking kernel accessible via a software interrupt that allows the current process to terminate itself.
5. Create a queue in the multitasking kernel called kbQ. This queue initially empty will contain characters typed by the user. Hook the keyboard interrupt for getting user keys. Convert the scan code to ASCII if the key is from a-z or 0-9 and enqueue it in kbQ. Ignore all other scan codes. Write a function checkkey accessible via a software interrupt that returns the process in AX a value removed from the queue. It waits if there is no key in the queue. Be aware of enabling interrupts if you wait here.
6. Modify the multitasking kernel such that the initial process displays at the last line of the screen whatever is typed by the user and clears that line on enter. If the user types quit followed by enter restore everything to normal as it was before the multitasking kernel was there. If the user types start followed by enter, start one more rotating bar on the screen. The first rotating bar should appear in the upper left, the next in the second column, then third and so on. The bar color should be white. The user can type the commands 'white', 'red', and 'green' to change the color of new bars.

12

Video Services

12.1. BIOS VIDEO SERVICES

The Basic Input Output System (BIOS) provides services for video, keyboard, serial port, parallel port, time etc. The video services are exported via INT 10. We will discuss some very simple services. Video services are classified into two broad categories; graphics mode services and text mode services. In graphics mode a location in video memory corresponds to a dot on the screen. In text mode this relation is not straightforward. The video memory holds the ASCII of the character to be shown and the actual shape is read from a font definition stored elsewhere in memory. We first present a list of common video services used in text mode.

INT 10 - VIDEO - SET VIDEO MODE

AH = 00h

AL = desired video mode

Some common video modes include 40x25 text mode (mode 0), 80x25 text mode (mode 2), 80x50 text mode (mode 3), and 320x200 graphics mode (mode D).

INT 10 - VIDEO - SET TEXT-MODE CURSOR SHAPE

AH = 01h

CH = cursor start and options

CL = bottom scan line containing cursor (bits 0-4)

INT 10 - VIDEO - SET CURSOR POSITION

AH = 02h

BH = page number

0-3 in modes 2&3

0-7 in modes 0&1

0 in graphics modes

DH = row (00h is top)

DL = column (00h is left)

INT 10 - VIDEO - SCROLL UP WINDOW

AH = 06h

AL = number of lines by which to scroll up (00h = clear entire window)

BH = attribute used to write blank lines at bottom of window

CH, CL = row, column of window's upper left corner

DH, DL = row, column of window's lower right corner

INT 10 - VIDEO - SCROLL DOWN WINDOW

AH = 07h

AL = number of lines by which to scroll down (00h=clear entire window)

BH = attribute used to write blank lines at top of window

CH, CL = row, column of window's upper left corner

DH, DL = row, column of window's lower right corner

INT 10 - VIDEO - WRITE CHARACTER AND ATTRIBUTE AT CURSOR POSITION

AH = 09h

AL = character to display

BH = page number

```

BL = attribute (text mode) or color (graphics mode)
CX = number of times to write character
INT 10 - VIDEO - WRITE CHARACTER ONLY AT CURSOR POSITION
AH = 0Ah
AL = character to display
BH = page number
BL = attribute (text mode) or color (graphics mode)
CX = number of times to write character
INT 10 - VIDEO - WRITE STRING
AH = 13h
AL = write mode
    bit 0: update cursor after writing
    bit 1: string contains alternating characters and attributes
    bits 2-7: reserved (0)
BH = page number
BL = attribute if string contains only characters
CX = number of characters in string
DH, DL = row, column at which to start writing
ES:BP -> string to write

```

Chargen Services

In our first example we will read the font definition in memory and change it to include a set of all on pixels in the last line showing an effect of underline on all character including space. An 8x16 font is stored in 16 bytes. A sample character and the corresponding 16 values stored in the font information are shown for the character 'A'. We start with two services from the chargen subset of video services that we are going to use.

```

INT 10 - VIDEO - GET FONT INFORMATION
AX = 1130h
BH = pointer specifier
Return:
ES:BP = specified pointer
CX = bytes/character of on-screen font
DL = highest character row on screen
INT 10 - TEXT-MODE CHARGEN
AX = 1110h
ES:BP -> user table
CX = count of patterns to store
DX = character offset into map 2 block
BL = block to load in map 2
BH = number of bytes per character pattern

```

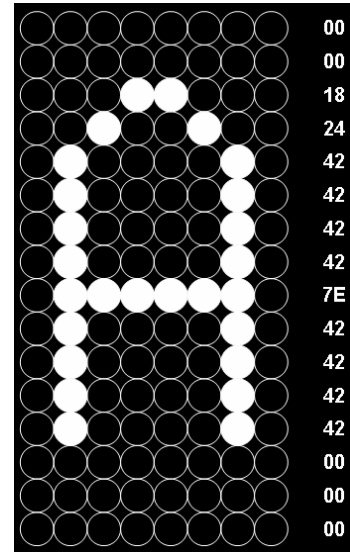

We will use 6 as the pointer specifier which means the 8x16 font stored in ROM.

Example 12.1	
001	; put underlines on screen font
002	[org 0x0100]
003	jmp start
004	
005	font: times 256*16 db 0 ; space for font
006	
007	start: mov ax, 0x1130 ; service 11/30 - get font info
008	mov bx, 0x0600 ; ROM 8x16 font
009	int 0x10 ; bios video services
010	
011	mov si, bp ; point si to rom font data
012	mov di, font ; point di to space for font

```

013          mov cx, 256*16          ; font size
014          push ds
015          push es
016          pop ds                  ; ds:si to rom font data
017          pop es                  ; es:di to space for font
018          cld                     ; auto increment mode
019          rep movsb               ; copy font
020
021          push cs
022          pop ds                  ; restore ds to data segment
023
024          mov si, font-1          ; point si before first char
025          mov cx, 0x100           ; total 256 characters
026  change:  add si, 16             ; one character has 16 bytes
027          mov byte [si], 0xFF     ; change last line to all ones
028          loop change             ; repeat for each character
029
030          mov bp, font            ; es:bp points to new font
031          mov bx, 0x1000          ; bytes per char & block number
032          mov cx, 0x100           ; number of characters to change
033          xor dx, dx              ; first character to change
034          mov ax, 0x1110          ; service 11/10 - load user font
035          int 0x10               ; bios video services
036
037          mov ax, 0x4c00          ; terminate program
038          int 0x21

```

Our second example is similar to the last example however in this case we are doing something funny on the screen. We are reversing the shapes of all the characters on the screen.

Example 12.2	
001	; reverse each character of screen font
002	[org 0x0100]
003	jmp start
004	
005	font: times 256*16 db 0 ; space for font
006	
007	start: mov ax, 0x1130 ; service 11/30 - get font info
008	mov bx, 0x0600 ; ROM 8x16 font
009	int 0x10 ; bios video services
010	
011	mov si, bp ; point si to rom font data
012	mov di, font ; point di to space for font
013	mov cx, 256*16 ; font size
014	push ds
015	push es
016	pop ds ; ds:si to rom font data
017	pop es ; es:di to space for font
018	cld ; auto increment mode
019	rep movsb ; copy font
020	
021	push cs
022	pop ds ; restore ds to data segment
023	
024	mov si, font ; point si to start of font
025	change: mov al, [si] ; read one byte
026	mov cx, 8
027	inner: shl al, 1 ; shift left with MSB in carry
028	rcr bl, 1 ; rotate right using carry
029	loop inner ; repeat eight times
030	mov [si], bl ; write back reversed byte
031	inc si ; next byte of font
032	cmp si, font+256*16 ; is whole font reversed
033	jne change ; no, reverse next byte
034	
035	mov bp, font ; es:bp points to new font
036	mov bx, 0x1000 ; bytes per char & block number
037	mov cx, 0x100 ; number of characters to change
038	xor dx, dx ; first character to change
039	mov ax, 0x1110 ; service 11/10 - load user font
040	int 0x10 ; bios video services
041	

```

042         mov ax, 0x4c00        ; terminate program
043         int  0x21

```

Graphics Mode Services

We will take an example of using graphics mode video services as well. We will draw a line across the screen using the following service.

```

INT 10 - VIDEO - WRITE GRAPHICS PIXEL
AH = 0Ch
BH = page number
AL = pixel color
CX = column
DX = row

```

Example 12.3

```

001         ; draw line in graphics mode
002         [org 0x0100]
003         mov ax, 0x000D        ; set 320x200 graphics mode
004         int  0x10            ; bios video services
005
006         mov ax, 0x0C07        ; put pixel in white color
007         xor bx, bx           ; page number 0
008         mov cx, 200          ; x position 200
009         mov dx, 200          ; y position 200
010
011     ll:   int  0x10            ; bios video services
012         dec dx               ; decrease y position
013         loop ll             ; decrease x position and repeat
014
015         mov ah, 0            ; service 0 - get keystroke
016         int  0x16            ; bios keyboard services
017
018         mov ax, 0x0003        ; 80x25 text mode
019         int  0x10            ; bios video services
020
021         mov ax, 0x4c00        ; terminate program
022         int  0x21

```

12.2. DOS VIDEO SERVICES

Services of DOS are more cooked and at a higher level than BIOS. They provide less control but make routine tasks much easier. Some important DOS services are listed below.

```

INT 21 - READ CHARACTER FROM STANDARD INPUT, WITH ECHO
AH = 01h
Return: AL = character read
INT 21 - WRITE STRING TO STANDARD OUTPUT
AH = 09h
DS:DX -> $ terminated string
INT 21 - BUFFERED INPUT
AH = 0Ah
DS:DX -> dos input buffer

```

The DOS input buffer has a special format where the first byte stores the maximum characters buffer can hold, the second byte holds the number of characters actually read on return, and the following space is used for the actual characters read. We start with an example of reading a string with service 1 and displaying it with service 9.

Example 12.4

```
001 ; character input using dos services
002 [org 0x0100]
003     jmp start
004
005     maxlength:    dw    80                ; maximum length of input
006     message:     db    10, 13, 'hello $' ; greetings message
007     buffer:      times 81 db 0          ; space for input string
008
009     start:        mov    cx, [maxlength] ; load maximum length in cx
010                 mov    si, buffer      ; point si to start of buffer
011
012     nextchar:    mov    ah, 1            ; service 1 - read character
013                 int    0x21           ; dos services
014
015                 cmp    al, 13         ; is enter pressed
016                 je     exit            ; yes, leave input
017                 mov    [sil], al      ; no, save this character
018                 inc    si             ; increment buffer pointer
019                 loop  nextchar        ; repeat for next input char
020
021     exit:        mov    byte [sil], '$' ; append $ to user input
022
023                 mov    dx, message    ; greetings message
024                 mov    ah, 9          ; service 9 - write string
025                 int    0x21           ; dos services
026
027                 mov    dx, buffer     ; user input buffer
028                 mov    ah, 9          ; service 9 - write string
029                 int    0x21           ; dos services
030
031                 mov    ax, 0x4c00     ; terminate program
032                 int    0x21
```

Our next example uses the more cooked buffered input service of DOS and using the same service 9 to print the string.

Example 12.5

```
001 ; buffer input using dos services
002 [org 0x0100]
003     jmp start
004
005     message:     db    10,13,'hello ', 10, 13, '$'
006     buffer:      db    80                ; length of buffer
007                 db    0                ; number of character on return
008                 times 80 db 0          ; actual buffer space
009
010     start:        mov    dx, buffer     ; input buffer
011                 mov    ah, 0x0A       ; service A - buffered input
012                 int    0x21           ; dos services
013
014                 mov    bh, 0
015                 mov    bl, [buffer+1] ; read actual size in bx
016                 mov    byte [buffer+2+bx], '$' ; append $ to user input
017
018                 mov    dx, message    ; greetings message
019                 mov    ah, 9          ; service 9 - write string
020                 int    0x21           ; dos services
021
022                 mov    dx, buffer+2   ; user input buffer
023                 mov    ah, 9          ; service 9 - write string
024                 int    0x21           ; dos services
025
026                 mov    ax, 0x4c00     ; terminate program
027                 int    0x21
```

More detail of DOS and BIOS interrupts is available in the Ralf Brown Interrupt List.

13

Secondary Storage

13.1. PHYSICAL FORMATION

A floppy disk is a circular plate with a fine coating of magnetic material over it. The plate is enclosed in a plastic jacket which has a cover that can slide to expose the magnetic surface. The drive motor attaches itself to the central piece and rotates the plate. Two heads on both sides can read the magnetically encoded data on the disk.

If the head is fixed and the motor rotates the disk the readable area on the disk surface forms a circle called a track. Head moved to the next step forms another track and so on. In hard disks the same structure is extended to a larger number of tracks and plates. The tracks are further cut vertically into sectors. This is a logical division of the area on the tracks. Each sector holds 512 bytes of data. A standard floppy disk has 80 tracks and 18 sectors per track with two heads, one on each side totalling to 2880 sectors or 1440 KB of data. Hard disks have varying number of heads and tracks pertaining to their different capacities.

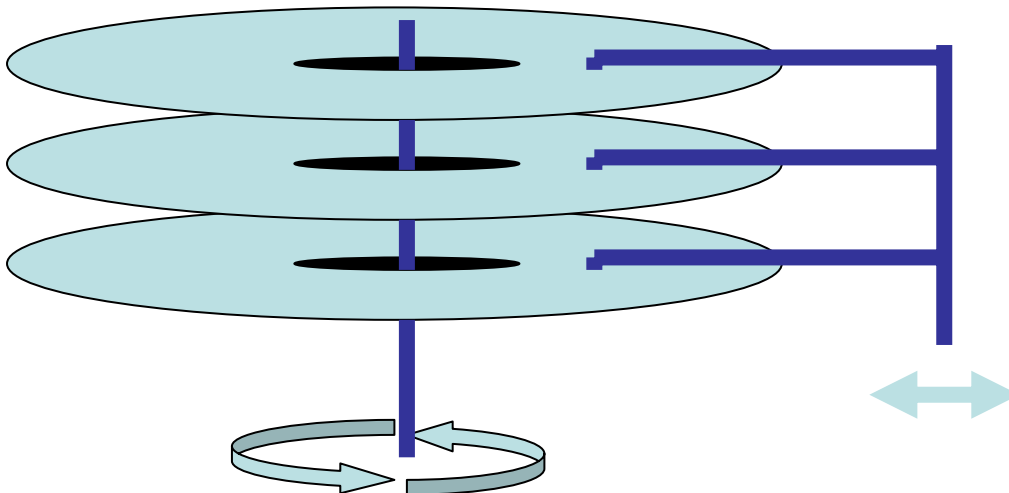

BIOS sees the disks as a combination of sectors, tracks, and heads, as a raw storage device without concern to whether it is reading a file or directory. BIOS provides the simplest and most powerful interface to the storage medium. However this raw storage is meaningless to the user who needs to store his files and organize them into directories. DOS builds a logical structure on this raw storage space to provide these abstractions. This logical formation is read and interpreted by DOS. If another file system is build on the same storage medium the interpretations change. Main units of the DOS structure are the boot sector in head 0, track 0, and sector 1, the first FAT starting from head 0, track 0, sector 2, the second copy of FAT starting from head 0, track 0, sector 11, and the root directory starting from head 1, track 0, sector 2. The area from head 0, track 1, sector 16 to head 1, track 79, sector 18 is used for storing the data of the files. Among this we will be exploring the directory structure further. The 32 sectors reserved for the root directory contain 512 directory entries. The format of a 32 byte directory entry is shown below.

Computer Architecture & Assembly Language Programming	Course Code: CS401
CS401@vu.edu.pk	VU

```

+00 Filename (8 bytes)
+08 Extension (3 bytes)
+0B Flag Byte (1 byte)
+0C Reserved (1 byte)
+0D Creation Date/Time (5 bytes)
+12 Last Accessed Data (2 bytes)
+14 Starting Cluster High Word (2 bytes) for FAT32
+16 Time (2 bytes)
+18 Date (2 bytes)
+1A Starting Cluster Low Word (2 bytes)
+1C File Size (4 bytes)

```

13.2. STORAGE ACCESS USING BIOS

We will be using BIOS disk services to directly see the data stored in the directory entries by DOS. For this purpose we will be using the BIOS disk services.

```

INT 13 - DISK - RESET DISK SYSTEM
AH = 00h
DL = drive
Return:
CF = error flag
AH = error code

INT 13 - DISK - READ SECTOR(S) INTO MEMORY
AH = 02h
AL = number of sectors to read (must be nonzero)
CH = low eight bits of cylinder number
CL = sector number 1-63 (bits 0-5)
      high two bits of cylinder (bits 6-7, hard disk only)
DH = head number
DL = drive number (bit 7 set for hard disk)
ES:BX -> data buffer
Return:
CF = error flag
AH = error code
AL = number of sectors transferred

INT 13 - DISK - WRITE DISK SECTOR(S)
AH = 03h
AL = number of sectors to write (must be nonzero)
CH = low eight bits of cylinder number
CL = sector number 1-63 (bits 0-5)
      high two bits of cylinder (bits 6-7, hard disk only)
DH = head number
DL = drive number (bit 7 set for hard disk)
ES:BX -> data buffer
Return:
CF = error flag
AH = error code
AL = number of sectors transferred

INT 13 - DISK - GET DRIVE PARAMETERS
AH = 08h
DL = drive (bit 7 set for hard disk)
Return:
CF = error flag
AH = error code
CH = low eight bits of maximum cylinder number
CL = maximum sector number (bits 5-0)

```

high two bits of maximum cylinder number (bits 7-6)
DH = maximum head number
DL = number of drives
ES:DI -> drive parameter table (floppies only)

Example 13.1

```

001 ; floppy directory using bios services
002 [org 0x0100]
003     jmp     start
004
005 sector:      times 512 db 0           ; space for directory sector
006 entryname:  times 11 db 0           ; space for a file name
007             db    10, 13, '$'      ; new line and terminating $
008
009 start:      mov     ah, 0             ; service 0 - reset disk system
010             mov     dl, 0             ; drive A:
011             int     0x13             ; bios disk services
012             jc     error             ; if error, terminate program
013
014             mov     ah, 2             ; service 2 - read sectors
015             mov     al, 1             ; count of sectors
016             mov     ch, 0             ; cylinder
017             mov     cl, 2             ; sector
018             mov     dh, 1             ; head
019             mov     dl, 0             ; drive A:
020             mov     bx, sector        ; buffer to read sector
021             int     0x13             ; bios disk services
022             jc     error             ; if error, terminate program
023
024             mov     bx, 0             ; start from first entry
025 nextentry:  mov     di, entryname     ; point di to space for filename
026             mov     si, sector        ; point si to sector
027             add     si, bx            ; move ahead to desired entry
028             mov     cx, 11           ; one filename is 11 bytes long
029             cld                       ; auto increment mode
030             rep     movsb            ; copy filename
031
032             mov     ah, 9             ; service 9 - output string
033             mov     dx, entryname     ; filename to be printed
034             int     0x21             ; dos services
035
036             add     bx, 32            ; point to next dir entry
037             cmp     bx, 512          ; is last entry in this sector
038             jne     nextentry        ; no, print next entry
039
040 error:      mov     ax, 0x4c00        ; terminate program
041             int     0x21

```

With the given services and the bits allocated for heads, tracks, and sectors only 8GB disks can be accessed. This limitation can be overcome by using INT 13 extensions that take a linear 64bit sector number and handle all the head, track, sector conversion themselves. The important services in this category are listed below.

INT 13 - INT 13 Extensions - EXTENDED READ

AH = 42h
DL = drive number
DS:SI -> disk address packet
Return:
CF = error flag
AH = error code
disk address packet's block count field set to number of blocks successfully transferred

INT 13 - INT 13 Extensions - EXTENDED WRITE

AH = 43h
AL = write flags

```

DL = drive number
DS:SI -> disk address packet
Return:
CF = error flag
AH = error code
        disk address packet's block count field set to number of blocks
        successfully transferred

```

The format of the disk address packet used above is as follows.

Offset	Size	Description
00h	BYTE	size of packet = 10h
01h	BYTE	reserved (0)
02h	WORD	number of blocks to transfer
04h	DWORD	-> transfer buffer
08h	QWORD	starting absolute block number

Hard disks have a different formation from floppy disks in that there is a partition table at the start that allows several logical disks to be maintained within a single physical disk. The physical sector 0 holds the master boot record and a partition table towards the end. The first 446 bytes contain MBR, then there are 4 16 byte partition entries and then there is a 2 byte signature. A partition table entry has the following format.

```

Byte 0 - 0x80 for active 0x00 for inactive
Byte 1-3 - Starting CHS
Byte 4 - Partition Type
Byte 5-7 - Ending CHS
Byte 8-B - Starting LBA
Byte C-F - Size of Partition

```

Some important partition types are listed below.

```

00 Unused Entry
01 FAT12
05 Extended Partition
06 FAT16
0b FAT32
0c FAT32 LBA
0e FAT16 LBA
0f Extended LBA
07 NTFS

```

Extended partition type signals that the specified area is treated as a complete hard disk with its own partition table and partitions. Therefore extended partitions allow a recursion in partitioning and consequently an infinite number of partitions are possible. The following program reads the partition tables (primary and extended) using recursion and displays in an indented form all partitions present on the first hard disk in the system.

Example 13.2	
001	; a program to display the partition table
002	[org 0x0100]
003	jmp start
004	
005	dap: db 0x10, 0 ; disk address packet
006	dw 1
007	dd 0, 0, 0

```

008
009-026 msg:          times 17 db ' '
027                db  10, 13, '$'
028 fat12:           db  'FAT12...$'
029 fat16:           db  'FAT16...$'
030 fat32:           db  'FAT32...$'
031 ntfs:            db  'NTFS...$'
032 extended:       db  'EXTEND..$'
033 unknown:        db  'UNKNOWN.$'
034
035 partypes:        dw  0x1, fat12      ; table of known partition types
036                dw  0x5, extended
037                dw  0x6, fat16
038                dw  0xe, fat16
039                dw  0xb, fat32
040                dw  0xc, fat32
041                dw  0x7, ntfs
042                dw  0xf, extended
043                dw  0x0, unknown
044
045 ; subroutine to print a number in a string as hex
046 ; takes address of string and a 16bit number as parameter
047 printnum:        push bp
048                mov  bp, sp
049                push ax
050                push bx
051                push cx
052                push dx
053                push di
054
055                mov  di, [bp+6]      ; string to store the number
056                add  di, 3
057
058                mov  ax, [bp+4]      ; load number in ax
059                mov  bx, 16          ; use base 16 for division
060                mov  cx, 4
061
062 nextdigit:        mov  dx, 0
063                div  bx              ; divide by 16
064                add  dl, 0x30        ; convert into ascii value
065                cmp  dl, 0x39
066                jbe  skipalpha
067
068                add  dl, 7
069
070 skipalpha:        mov  [di], dl      ; update char in string
071                dec  di
072                loop nextdigit
073
074                pop  di
075                pop  dx
076                pop  cx
077                pop  bx
078                pop  ax
079                pop  bp
080                ret  4
081
082 ; subroutine to print the start and end of a partition
083 ; takes the segment and offset of the partition table entry
084 printpart:        push bp
085                mov  bp, sp
086                push es
087                push ax
088                push di
089
090                les  di, [bp+4]      ; point es:di to dap
091
092                mov  ax, msg
093                push ax
094                push word [es:di+0xA]
095                call printnum        ; print first half of start
096
097                add  ax, 4
098                push ax
099                push word [es:di+0x8]
100                call printnum        ; print second half of start

```

```

101
102         add ax, 5
103         push ax
104         push word [es:di+0xE]
105         call printnum           ; print first half of end
106
107         add ax, 4
108         push ax
109         push word [es:di+0xC]
110         call printnum           ; print second half of end
111
112         mov dx, msg
113         mov ah, 9
114         int 0x21                 ; print the whole on the screen
115
116         pop di
117         pop ax
118         pop es
119         pop bp
120         ret 4
121
122         ; recursive subroutine to read the partition table
123         ; take indentation level and 32bit absolute block number as parameters
124 readpart: push bp
125         mov bp, sp
126         sub sp, 512             ; local space to read sector
127         push ax
128         push bx
129         push cx
130         push dx
131         push si
132
133         mov ax, bp
134         sub ax, 512
135         mov word [dap+4], ax    ; init dest offset in dap
136         mov [dap+6], ds        ; init dest segment in dap
137         mov ax, [bp+4]
138         mov [dap+0x8], ax      ; init sector no in dap
139         mov ax, [bp+6]
140         mov [dap+0xA], ax     ; init second half of sector no
141
142         mov ah, 0x42           ; read sector in LBA mode
143         mov dl, 0x80           ; first hard disk
144         mov si, dap            ; address of dap
145         int 0x13              ; int 13
146
147         jc failed             ; if failed, leave
148
149         mov si, -66            ; start of partition info
150 nextpart: mov ax, [bp+4]       ; read relative sector number
151         add [bp+si+0x8], ax    ; make it absolute
152         mov ax, [bp+6]        ; read second half
153         adc [bp+si+0xA], ax   ; make second half absolute
154
155         cmp byte [bp+si+4], 0 ; is partition unused
156         je exit
157
158         mov bx, partypes      ; point to partition types
159 nextmatch: mov di, 0
160         mov ax, [bx+di]
161         cmp [bp+si+4], al     ; is this partition known
162         je found              ; yes, so print its name
163         add di, 4              ; no, try next entry in table
164         cmp di, 32            ; are all entries compared
165         jne nextmatch        ; no, try another
166
167         found: mov cx, [bp+8] ; load indentation level
168         jcxz noindent         ; skip if no indentation needed
169         indent: mov dl, ' '
170         mov ah, 2             ; display char service
171         int 0x21              ; dos services
172         loop indent           ; print required no of spaces
173
174         noindent: add di, 2
175         mov dx, [bx+di]       ; point to partition type name
176         mov ah, 9             ; print string service
177

```



```

178             int  0x21             ; dos services
179
180             push ss
181             mov  ax, bp
182             add  ax, si
183             push ax                ; pass partition entry address
184             call printpart         ; print start and end from it
185
186             cmp  byte [bp+si+4], 5  ; is it an extended partition
187             je   recurse           ; yes, make a recursive call
188
189             cmp  byte [bp+si+4], 0xf ; is it an extended partition
190             jne  exit              ; yes, make a recursive call
191
192  recurse:    mov  ax, [bp+8]
193             add  ax, 2              ; increase indentation level
194             push ax
195             push word [bp+si+0xA]  ; push partition type address
196             push word [bp+si+0x8]
197             call readpart          ; recursive call
198
199  exit:       add  si, 16            ; point to next partition entry
200             cmp  si, -2            ; gone past last entry
201             jne  nextpart          ; no, read this entry
202
203  failed:    pop  si
204             pop  dx
205             pop  bx
206             pop  cx
207             pop  ax
208             mov  sp, bp
209             pop  bp
210             ret  6
211
212  start:     xor  ax, ax
213             push ax                ; start from zero indentation
214             push ax                ; main partition table at 0
215             push ax
216             call readpart          ; read and print it
217
218             mov  ax, 0x4c00        ; terminate program
219             int  0x21

```

13.3. STORAGE ACCESS USING DOS

BIOS provides raw access to the storage medium while DOS gives a more logical view and more cooked services. Everything is a file. A directory is a specially organized file that is interpreted by the operating system itself. A list of important DOS services for file manipulation is given below.

INT 21 - CREATE OR TRUNCATE FILE

AH = 3Ch
CX = file attributes
DS:DX -> ASCIZ filename
Return:
CF = error flag
AX = file handle or error code

INT 21 - OPEN EXISTING FILE

AH = 3Dh
AL = access and sharing modes
DS:DX -> ASCIZ filename
CL = attribute mask of files to look for (server call only)
Return:
CF = error flag
AX = file handle or error code

INT 21 - CLOSE FILE

AH = 3Eh

Computer Architecture & Assembly Language Programming	Course Code: CS401
CS401@vu.edu.pk	VU

```

BX = file handle
Return:
CF = error flag
AX = error code
INT 21 - READ FROM FILE
AH = 3Fh
BX = file handle
CX = number of bytes to read
DS:DX -> buffer for data
Return:
CF = error flag
AX = number of bytes actually read or error code
INT 21 - WRITE TO FILE
AH = 40h
BX = file handle
CX = number of bytes to write
DS:DX -> data to write
Return:
CF = error flag
AX = number of bytes actually written or error code
INT 21 - DELETE FILE
AH = 41h
DS:DX -> ASCIZ filename (no wildcards, but see notes)
Return:
CF = error flag
AX = error code
INT 21 - SET CURRENT FILE POSITION
AH = 42h
AL = origin of move
BX = file handle
CX:DX = offset from origin of new file position
Return:
CF = error flag
DX:AX = new file position in bytes from start of file
AX = error code in case of error
INT 21 - GET FILE ATTRIBUTES
AX = 4300h
DS:DX -> ASCIZ filename
Return:
CF = error flag
CX = file attributes
AX = error code
INT 21 - SET FILE ATTRIBUTES
AX = 4301h
CX = new file attributes
DS:DX -> ASCIZ filename
Return:
CF = error flag
AX = error code

```

We will use some of these services to find that two files are same in contents or different. We will read the file names from the command prompt. The command string is passed to the program in the program segment prefix located at offset 0 in the current segment. The area from 0-7F contains information for DOS, while the command tail length is stored at 80. From 81 to FF, the actual command tail is stored terminated by a CR (Carriage Return).

Example 13.3

```
001 ; file comparison using dos services
002 [org 0x0100]
003 jmp start
004
005 filename1: times 128 db 0 ; space for first filename
006 filename2: times 128 db 0 ; space for second filename
007 handle1: dw 0 ; handle for first file
008 handle2: dw 0 ; handle for second file
009 buffer1: times 4096 db 0 ; buffer for first file
010 buffer2: times 4096 db 0 ; buffer for second file
011
012 format: db 'Usage error: diff <filename1> <filename2>$('
013 openfailed: db 'First file could not be opened$('
014 openfailed2: db 'Second file could not be opened$('
015 readfailed: db 'First file could not be read$('
016 readfailed2: db 'Second file could not be read$('
017 different: db 'Files are different$('
018 same: db 'Files are same$('
019
020 start: mov ch, 0
021 mov cl, [0x80] ; command tail length in cx
022 dec cx ; leave the first space
023 mov di, 0x82 ; start of command tail in di
024 mov al, 0x20 ; space for parameter separation
025 cld ; auto increment mode
026 repne scasb ; search space
027 je param2 ; if found, proceed
028 mov dx, format ; else, select error message
029 jmp error ; proceed to error printing
030
031 param2: push cx ; save original cx
032 mov si, 0x82 ; set si to start of param
033 mov cx, di ; set di to end of param
034 sub cx, 0x82 ; find param size in cx
035 dec cx ; excluding the space
036 mov di, filename1 ; set di to space for filename 1
037 rep movsb ; copy filename there
038 mov byte [di], 0 ; terminate filename with 0
039 pop cx ; restore original cx
040 inc si ; go to start of next filename
041 mov di, filename2 ; set di to space for filename 2
042 rep movsb ; copy filename there
043 mov byte [di], 0 ; terminate filename with 0
044
045 mov ah, 0x3d ; service 3d - open file
046 mov al, 0 ; readonly mode
047 mov dx, filename1 ; address of filename
048 int 0x21 ; dos services
049 jnc open2 ; if no error, proceed
050 mov dx, openfailed ; else, select error message
051 jmp error ; proceed to error printing
052
053 open2: mov [handle1], ax ; save handle for first file
054 mov ah, 0x3d ; service 3d - open file
055 mov al, 0 ; readonly mode
056 mov dx, filename2 ; address of filename
057 int 0x21 ; dos services
058 jnc store2 ; if no error, proceed
059 mov dx, openfailed2 ; else, select error message
060 jmp error ; proceed to error printing
061
062 store2: mov [handle2], ax ; save handle for second file
063
064 readloop: mov ah, 0x3f ; service 3f - read file
065 mov bx, [handle1] ; handle for file to read
066 mov cx, 4096 ; number of bytes to read
067 mov dx, buffer1 ; buffer to read in
068 int 0x21 ; dos services
069 jnc read2 ; if no error, proceed
070 mov dx, readfailed ; else, select error message
071 jmp error ; proceed to error printing
072
073 read2: push ax ; save number of bytes read
074 mov ah, 0x3f ; service 3f - read file
```

```

075          mov  bx, [handle2]      ; handle for file to read
076          mov  cx, 4096          ; number of bytes to read
077          mov  dx, buffer2       ; buffer to read in
078          int  0x21              ; dos services
079          jnc  check             ; if no error, proceed
080          mov  dx, readfailed2    ; else, select error message
081          jmp  error             ; proceed to error printing
082
083  check:   pop  cx                ; number of bytes read of file 1
084          cmp  ax, cx            ; are number of byte same
085          je   check2           ; yes, proceed to compare them
086          mov  dx, different     ; no, files are different
087          jmp  error            ; proceed to message printing
088
089  check2:  test ax, ax           ; are zero bytes read
090          jnz  compare          ; no, compare them
091          mov  dx, same          ; yes, files are same
092          jmp  error            ; proceed to message printing
093
094  compare: mov  si, buffer1       ; point si to file 1 buffer
095          mov  di, buffer2       ; point di to file 2 buffer
096          repe cmpsb            ; compare the two buffers
097          je   check3           ; if equal, proceed
098          mov  dx, different     ; else, files are different
099          jmp  error            ; proceed to message printing
100
101  check3:  cmp  ax, 4096         ; were 4096 bytes read
102          je   readloop         ; yes, try to read more
103          mov  dx, same         ; no, files are same
104
105  error:   mov  ah, 9            ; service 9 - output message
106          int  0x21             ; dos services
107
108          mov  ah, 0x3e          ; service 3e - close file
109          mov  bx, [handle1]     ; handle of file to close
110          int  0x21             ; dos services
111
112          mov  ah, 0x3e          ; service 3e - close file
113          mov  bx, [handle2]     ; handle of file to close
114          int  0x21             ; dos services
115
116          mov  ax, 0x4c00        ; terminate program
117          int  0x21

```

Another interesting service that DOS provides regarding files is executing them. An important point to understand here is that whenever a program is executed in DOS all available memory is allocated to it. No memory is available to execute any new programs. Therefore memory must be freed using explicit calls to DOS for this purpose before a program is executed. Important services in this regard are listed below.

INT 21 - ALLOCATE MEMORY

AH = 48h
 BX = number of paragraphs to allocate
 Return:
 CF = error flag
 AX = segment of allocated block or error code in case of error
 BX = size of largest available block in case of error

INT 21 - FREE MEMORY

AH = 49h
 ES = segment of block to free
 Return:
 CF = error flag

AX = error code

INT 21 - RESIZE MEMORY BLOCK

AH = 4Ah
 BX = new size in paragraphs
 ES = segment of block to resize

```

Return:
CF = error flag
AX = error code
BX = maximum paragraphs available for specified memory block
INT 21 - LOAD AND/OR EXECUTE PROGRAM
AH = 4Bh
AL = type of load (0 = load and execute)
DS:DX -> ASCIZ program name (must include extension)
ES:BX -> parameter block
Return:
CF = error flag
AX = error code

```

The format of parameter block is as follows.

Offset	Size	Description
00h	WORD	segment of environment to copy for child process (copy caller's environment if 0000h)
02h	DWORD	pointer to command tail to be copied into child's PSP
06h	DWORD	pointer to first FCB to be copied into child's PSP
0Ah	DWORD	pointer to second FCB to be copied into child's PSP
0Eh	DWORD	(AL=01h) will hold subprogram's initial SS:SP on return
12h	DWORD	(AL=01h) will hold entry point (CS:IP) on return

As an example we will use the multitasking kernel client from the multitasking chapter and modify it such that after running all three threads it executes a new instance of the command prompt instead of indefinitely hanging around.

Example 13.4	
001	; another multitasking TSR caller
002	[org 0x0100]
003	jmp start
004	
005	; parameter block layout:
006	; cs,ip,ds,es,param
007	; 0, 2, 4, 6, 8
008	
009	paramblock: times 5 dw 0 ; space for parameters
010	lineno: dw 0 ; line number for next thread
011	chars: db '\ /-' ; chracters for rotating bar
012	message: db 'moving hello' ; moving string
013	message2: db ' ' ; to erase previous string
014	messagelen: dw 12 ; length of above strings
015	tail: db ' ',13
016	command: db 'COMMAND.COM', 0
017	execblock: times 11 dw 0
018	
019-062	;;;; COPY LINES 028-071 FROM EXAMPLE 10.1 (printnum) ;;;;
063-104	;;;; COPY LINES 073-114 FROM EXAMPLE 10.1 (printstr) ;;;;
104-127	;;;; COPY LINES 103-126 FROM EXAMPLE 11.5 (mytask) ;;;;
128-146	;;;; COPY LINES 128-146 FROM EXAMPLE 11.5 (mytask2) ;;;;
147-192	;;;; COPY LINES 148-193 FROM EXAMPLE 11.5 (mytask3) ;;;;
193	
194	start: mov [paramblock+0], cs ; code segment parameter
195	mov word [paramblock+2], mytask ; offset parameter
196	mov [paramblock+4], ds ; data segment parameter
197	mov [paramblock+6], es ; extra segment parameter
198	mov word [paramblock+8], 0 ; parameter for thread
199	mov si, paramblock ; address of param block in si
200	int 0x80 ; multitasking kernel interrupt
201	
202	mov [paramblock+0], cs ; code segment parameter
203	mov word [paramblock+2], mytask2 ; offset parameter
204	mov [paramblock+4], ds ; data segment parameter

```

205          mov [parablock+6], es ; extra segment parameter
206          mov word [parablock+8], 0 ; parameter for thread
207          mov si, parablock      ; address of param block in si
208          int 0x80              ; multitasking kernel interrupt
209
210          mov [parablock+0], cs ; code segment parameter
211          mov word [parablock+2], mytask3 ; offset parameter
212          mov [parablock+4], ds ; data segment parameter
213          mov [parablock+6], es ; extra segment parameter
214          mov word [parablock+8], 0 ; parameter for thread
215          mov si, parablock      ; address of param block in si
216          int 0x80              ; multitasking kernel interrupt
217
218          mov ah, 0x4a          ; service 4a - resize memory
219          mov bx, end           ; end of memory retained
220          add bx, 15            ; rounding up
221          mov cl, 4
222          shr bx, cl            ; converting into paras
223          int 0x21              ; dos services
224
225          mov ah, 0x4b          ; service 4b - exec
226          mov al, 0             ; load and execute
227          mov dx, command       ; command to be executed
228          mov bx, execblock     ; address of execblock
229          mov word [bx+2], tail  ; offset of command tail
230          mov [bx+4], ds        ; segment of command tail
231          int 0x21              ; dos services
232
233          jmp $                  ; loop infinitely if returned
234      end:

```

13.4. DEVICE DRIVERS

Device drivers are operating system extensions that become part of the operating system and extend its services to new devices. Device drivers in DOS are very simple. They just have their services exposed through the file system interface.

Device driver file starts with a header containing a link to the next driver in the first four bytes followed by a device attribute word. The most important bit in the device attribute word is bit 15 which dictates if it is a character device or a block device. If the bit is zero the device is a character device and otherwise a block device. Next word in the header is the offset of a strategy routine, and then is the offset of the interrupt routine and then in one byte, the number of units supported is stored. This information is padded with seven zeroes.

Strategy routine is called whenever the device is needed and it is passed a request header. Request header stores the unit requested, the command code, space for return value and buffer pointers etc. Important command codes include 0 to initialize, 1 to check media, 2 to build a BIOS parameter block, 4 and 8 for read and write respectively. For every command the first 13 bytes of request header are same.

RH+0	BYTE	Length of request header
RH+1	BYTE	Unit requested
RH+2	BYTE	Command code
RH+3	BYTE	Driver's return code
RH+5	9 BYTES	Reserved

The request header details for different commands is listed below.

0 - Driver Initialization

Passed to driver

RH+18 DWORD Pointer to character after equal sign on CONFIG.SYS line that loaded driver (read-only)

Computer Architecture & Assembly Language Programming	Course Code: CS401
CS401@vu.edu.pk	VU

```

RH+22  BYTE   Drive number for first unit of this block driver
(0=A...)
Return from driver
RH+13  BYTE   Number of units (block devices only)
RH+14  DWORD  Address of first free memory above driver (break
address)
RH+18  DWORD  BPB pointer array (block devices only)
1 - Media Check
RH+13  BYTE   Media descriptor byte
Return
RH+14  BYTE   Media change code
                -1 if disk changed
                0 if dont know whether disk changed
                1 if disk not changed
RH+15  DWORD  pointer to previous volume label if device attrib bit
11=1 (open/close/removable media supported)
2 - Build BPB
RH+13  BYTE   Media descriptor byte
RH+14  DWORD  buffer address (one sector)
Return
RH+18  DWORD  pointer to new BPB
if bit 13 (ibm format) is set buffer is first sector of fat, otherwise
scrach space
4 - Read / 8 - Write / 9 - Write with verify
RH+13  BYTE   Media descriptor byte
RH+14  DWORD  transfer address
RH+18  WORD   byte or sector count
RH+20  WORD   starting sector number (for block devices)
Return
RH+18  WORD   actual byte or sectors transferred
RH+22  DWORD  pointer to volume label if error 0Fh is returned

```

The BIOS parameter block discussed above is a structure that provides parameters about the storage medium. It is stored in the first sector or the boot sector of the device. Its contents are listed below.

```

00-01  bytes per sector
02     sectors per allocation unit
03-04  Number of reserved sectors ( 0 based)
05     number of file allocation tables
06-07  max number of root directory entries
08-09  total number of sectors in medium
0A     media descriptor byte
0B-0C  number of sectors occupied by a single FAT
0D-0E  sectors per track (3.0 or later)
0F-10  number of heads (3.0 or later)
11-12  number of hidden sectors (3.0 or later)
13-14  high-order word of number of hidden sectors (4.0)
15-18  IF bytes 8-9 are zero, total number of sectors in medium
19-1E  Reserved should be zero

```

We will be building an example device driver that takes some RAM and expresses it as a secondary storage device to the operating system. Therefore a new drive is added and that can be browsed to, files copied to and from just like ordinary drives expect that this drive is very fast as it is located in the RAM. This program cannot be directly executed since it is not a user program. This must be loaded by adding the line "device=filename.sys" in the "config.sys" file in the root directory.

Example 13.5

```

001 ; ram disk dos block device driver
002 header: dd -1 ; no next driver
003 dw 0x2000 ; driver attributes: block device
004 dw strategy ; offset of strategy routine
005 dw interrupt ; offset of interrupt routine
006 db 1 ; no of units supported
007 times 7 db 0 ; reserved
008
009 request: dd 0 ; space for request header
010
011 ramdisk: times 11 db 0 ; initial part of boot sector
012 bpb: dw 512 ; bytes per sector
013 db 1 ; sectors per cluster
014 dw 1 ; reserved sectors
015 db 1 ; fat copies
016 dw 48 ; root dir entries
017 dw 105 ; total sectors
018 db 0xf8 ; media desc byte: fixed disk
019 dw 1 ; sectors per fat
020 times 482 db 0 ; remaining part of boot sector
021 db 0xfe, 0xff, 0xff ; special bytes at start of FAT
022 times 509 db 0 ; remaining FAT entries unused
023 times 103*512 db 0 ; 103 sectors for data
024 bpbptr: dw bpb ; array of bpb pointers
025
026 dispatch: dw init ; command 0: init
027 dw mediacheck ; command 1: media check
028 dw getbpb ; command 2: get bpb
029 dw unknown ; command 3: not handled
030 dw input ; command 4: input
031 dw unknown ; command 5: not handled
032 dw unknown ; command 6: not handled
033 dw unknown ; command 7: not handled
034 dw output ; command 8: output
035 dw output ; command 9: output with verify
036
037 ; device driver strategy routine
038 strategy: mov [cs:request], bx ; save request header offset
039 mov [cs:request+2], es ; save request header segment
040 retf
041
042 ; device driver interrupt routine
043 interrupt: push ax
044 push bx
045 push cx
046 push dx
047 push si
048 push di
049 push ds
050 push es
051
052 push cs
053 pop ds
054
055 les di, [request]
056 mov word [es:di+3], 0x0100
057 mov bl, [es:di+2]
058 mov bh, 0
059 cmp bx, 9
060 ja skip
061 shl bx, 1
062
063 call [dispatch+bx]
064
065 skip: pop es
066 pop ds
067 pop di
068 pop si
069 pop dx
070 pop cx
071 pop bx
072 pop ax
073 retf
074

```



```

075 mediacheck: mov byte [es:di+14], 1
076             ret
077
078 getbpb:     mov word [es:di+18], bpb
079             mov [es:di+20], ds
080             ret
081
082 input:      mov ax, 512
083             mul word [es:di+18]
084             mov cx, ax
085
086             mov ax, 512
087             mul word [es:di+20]
088             mov si, ax
089             add si, ramdisk
090
091             les di, [es:di+14]
092             cld
093             rep movsb
094             ret
095
096 output:     mov ax, 512
097             mul word [es:di+18]
098             mov cx, ax
099
100             lds si, [es:di+14]
101             mov ax, 512
102             mul word [es:di+20]
103             mov di, ax
104             add di, ramdisk
105
106             push cs
107             pop es
108             cld
109             rep movsb
110 unknown:   ret
111
112 init:       mov ah, 9
113             mov dx, message
114             int 0x21
115
116             mov byte [es:di+13], 1
117             mov word [es:di+14], init
118             mov [es:di+16], ds
119             mov word [es:di+18], bpbptr
120             mov [es:di+20], ds
121             ret
122
123 message:   db 13, 10, 'RAM Disk Driver loaded',13,10,'$'
    
```

Serial Port Programming

14.1. INTRODUCTION

Serial port is a way of communication among two devices just like the parallel port. The basic difference is that whole bytes are sent from one place to another in case of parallel port while the bits are sent one by one on the serial port in a specially formatted fashion. The serial port connection is a 9pin DB-9 connector with pins assigned as shown below.

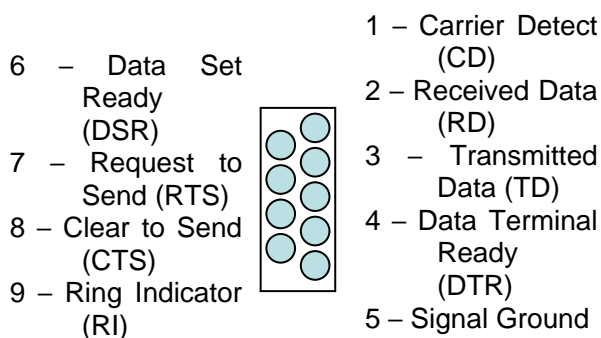

We have made a wire that connects signal ground of the two connectors, the TD of one to the RD of the other and the RD of one to the TD of the other. This three wire connection is sufficient for full duplex serial communication. The data on the serial port is sent in a standard format called RS232 communication. The data starts with a 1 bit called the start bit, then five to eight data bits, an optional parity bit, and one to two 0 bits called stop bits. The number of data bits, parity bits, and the number of stop bits have to be configured at both ends. Also the duration of a bit must be precisely known at both ends called the baud rate of the communication.

The BIOS INT 14 provides serial port services. We will use a mix of BIOS services and direct port access for our example. A major limitation in using BIOS is that it does not allow interrupt driven data transfer, i.e. we are interrupted whenever a byte is ready to be read or a byte can be transferred since the previous transmission has completed. To achieve this we have to resort to direct port access. Important BIOS services regarding the serial port are discussed below.

```

INT 14 - SERIAL - INITIALIZE PORT
AH = 00h
AL = port parameters
DX = port number (00h-03h)
Return:
AH = line status
AL = modem status

```

Every bit of line status conveys different information. From most significant to least significant, the meanings are timeout, transmitter shift register empty, transmitter holding register empty, break detect, receiver ready, overrun, parity error, and framing error. Modem status is not used in direct serial communication. The port parameters in AL consist of the baud

rate, parity scheme, number of stop bits, and number of data bits. The description of various bits is as under.

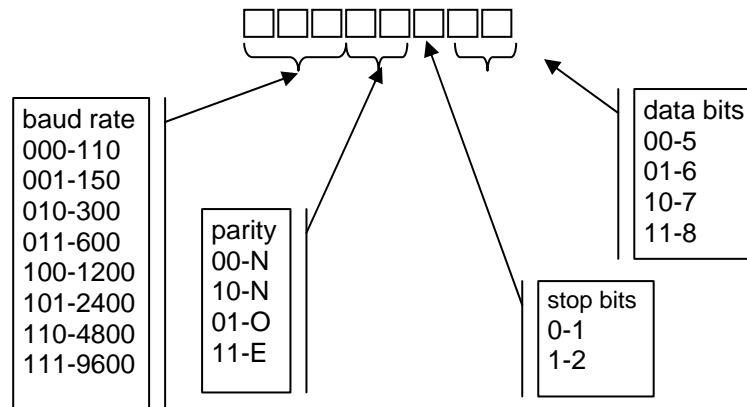

INT 14 - SERIAL - WRITE CHARACTER TO PORT

AH = 01h
 AL = character to write
 DX = port number (00h-03h)
 Return:
 AH bit 7 = error flag

AH bits 6-0 = port status

INT 14 - SERIAL - READ CHARACTER FROM PORT

AH = 02h
 DX = port number (00h-03h)
 Return:
 AH = line status
 AL = received character if AH bit 7 clear

INT 14 - SERIAL - GET PORT STATUS

AH = 03h
 DX = port number (00h-03h)
 Return:
 AH = line status
 AL = modem status

Serial port is also accessible via I/O ports. COM1 is accessible via ports 3F8-3FF while COM2 is accessible via 2F8-2FF. The first register at 3F8 (or 2F8 for the other port) is the transmitter holding register if written to and the receiver buffer register if read from. Other registers of our interest include 3F9 whose bit 0 must be set to enable received data available interrupt and bit 1 must be set to enable transmitter holding register empty interrupt. Bit 0 of 3FA is set if an interrupt is pending and its bits 1-3 identify the cause of the interrupt. The three bit causes are as follows.

- 110 (16550, 82510) timeout interrupt pending
- 101 (82510) timer interrupt
- 100 (82510) transmit machine
- 011 receiver line status interrupt. priority=highest
- 010 received data available register interrupt. priority=second
- 001 transmitter holding register empty interrupt. priority=third
- 000 modem status interrupt. priority=fourth

The register at 3FB is line control register while the one at 3FD is line status register. The line status register has the same bits as returned in line status by the get port status BIOS interrupt however the most significant bit

is reserved in this case instead of signaling a timeout. The register at 3FC is the modem control register. Bit 3 of this register must be set to enable interrupt generation by the serial port.

14.2. SERIAL COMMUNICATION

We give an example where two computers are connected using a serial cable made just as described above. The program is to be run on both computers. After that whatever is typed on one computer appears on the screen of the other.

Example 14.1

```

001 ; a program using serial port to transfer data back and forth
002 [org 0x0100]
003         jmp  start
004
005 screenpos:  dw  0           ; where to display next character
006
007 ; subroutine to clear the screen
008 clrscr:   push es
009         push ax
010         push cx
011         push di
012
013         mov  ax, 0xb800
014         mov  es, ax        ; point es to video base
015         xor  di, di        ; point di to top left column
016         mov  ax, 0x0720    ; space char in normal attribute
017         mov  cx, 2000     ; number of screen locations
018
019         cld                ; auto increment mode
020         rep  stosw        ; clear the whole screen
021
022         pop  di
023         pop  cx
024         pop  ax
025         pop  es
026         ret
027
028 serial:   push ax
029         push bx
030         push dx
031         push es
032
033         mov  dx, 0x3FA     ; interrupt identification register
034         in  al, dx        ; read register
035         and  al, 0x0F     ; leave lowernibble only
036         cmp  al, 4        ; is receiver data available
037         jne  skipall     ; no, leave interrupt handler
038
039         mov  dx, 0x3F8     ; data register
040         in  al, dx        ; read character
041
042         mov  dx, 0xB800
043         mov  es, dx        ; point es to video memory
044         mov  bx, [cs:screenpos] ; get current screen position
045         mov  [es:bx], al   ; write character on screen
046         add  word [cs:screenpos], 2 ; update screen position
047         cmp  word [cs:screenpos], 4000 ; is the screen full
048         jne  skipall     ; no, leave interrupt handler
049
050         call clrscr        ; clear the screen
051         mov  word [cs:screenpos], 0 ; reset screen position
052
053 skipall:   mov  al, 0x20
054         out  0x20, al     ; end of interrupt
055
056         pop  es
057         pop  dx
058         pop  bx
059         pop  ax
060         iret

```

```

061
062     start:      call clrscr          ; clear the screen
063
064             mov  ah, 0              ; initialize port service
065             mov  al, 0xE3           ; line settings = 9600, 8, N, 1
066             xor  dx, dx             ; port = COM1
067             int  0x14               ; BIOS serial port services
068
069             xor  ax, ax
070             mov  es, ax             ; point es to IVT base
071             mov  word [es:0x0C*4], serial
072             mov  [es:0x0C*4+2], cs ; hook serial port interrupt
073
074             mov  dx, 0x3FC          ; modem control register
075             in   al, dx             ; read register
076             or   al, 8              ; enable bit 3 (OUT2)
077             out  dx, al            ; write back to register
078
079             mov  dx, 0x3F9          ; interrupt enable register
080             in   al, dx             ; read register
081             or   al, 1              ; receiver data interrupt enable
082             out  dx, al            ; write back to register
083
084             in   al, 0x21           ; read interrupt mask register
085             and  al, 0xEF           ; enable IRQ 4
086             out  0x21, al          ; write back to register
087
088     main:      mov  ah, 0            ; read key service
089             int  0x16              ; BIOS keyboard services
090             push ax                 ; save key for later use
091
092     retest:   mov  ah, 3            ; get line status
093             xor  dx, dx             ; port = COM1
094             int  0x14              ; BIOS keyboard services
095             and  ah, 32             ; trasmitter holding register empty
096             jz   retest            ; no, test again
097
098             pop  ax                 ; load saved key
099             mov  dx, 0x3F8          ; data port
100             out  dx, al            ; send on serial port
101
102             jmp  main

```

15

Protected Mode Programming

15.1. INTRODUCTION

Till now we have been discussing the 8088 architecture which was a 16bit processor. Newer processors of the Intel series provide 32bit architecture. Till now we were in real mode of a newer processor which is basically a compatibility mode making the newer processor just a faster version of the original 8088. Switching processor in the newer 32bit mode is a very easy task. Just turn on the least significant bit of a new register called CR0 (Control Register 0) and the processor switches into 32bit mode called protected mode. However manipulations in the protected mode are very different from those in the real mode.

All registers in 386 have been extended to 32bits. The new names are EAX, EBX, ECX, EDX, ESI, EDI, ESP, EBP, EIP, and EFLAGS. The original names refer to the lower 16bits of these registers. A 32bit address register can access upto 4GB of memory so memory access has increased a lot.

As regards segment registers the scheme is not so simple. First of all we call them segment selectors instead of segment registers and they are still 16bits wide. We are also given two other segment selectors FS and GS for no specific purpose just like ES.

The working of segment registers as being multiplied by 10 and added into the offset for obtaining the physical address is totally changed. Now the selector is just an index into an array of segment descriptors where each descriptor describes the base, limit, and attributes of a segment. Role of selector is to select on descriptor from the table of descriptors and the role of descriptor is to define the actual base address. This decouples the selection and actual definition which is needed in certain protection mechanisms introduced into this processor. For example an operating system can define the possible descriptors for a program and the program is bound to select one of them and nothing else. This sentence also hints that the processor has some sense of programs that can or cannot do certain things like change this table of descriptors. This is called the privilege level of the program and varies for 0 (highest privilege) to 3 (lowest privilege). The format of a selector is shown below.

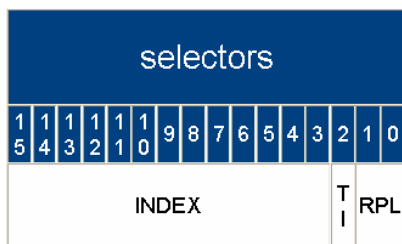

The table index (TI) is set to 0 to access the global table of descriptors called the GDT (Global Descriptor Table). It is set to 1 to access another table, the local descriptor table (LDT) that we will not be using. RPL is the requested privilege level that ranges from 0-3 and informs what privilege level

the program wants when using this descriptor. The 13bit index is the actual index into the GDT to select the appropriate descriptor. 13 bits mean that a maximum of 8192 descriptors are possible in the GDT.

The GDT itself is an array of descriptors where each descriptor is an 8byte entry. The base and limit of GDT is stored in a 48bit register called the GDTR. This register is loaded with a special instruction LGDT and is given a memory address from where the 48bits are fetched. The first entry of the GDT must always be zero. It is called the null descriptor. After that any number of entries upto a maximum of 8191 can follow. The format of a code and data descriptor is shown below.

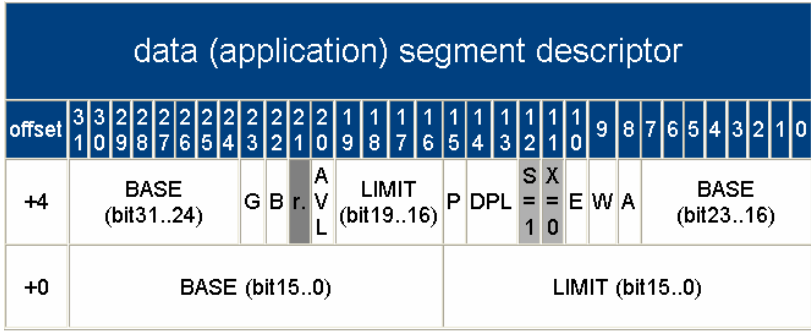
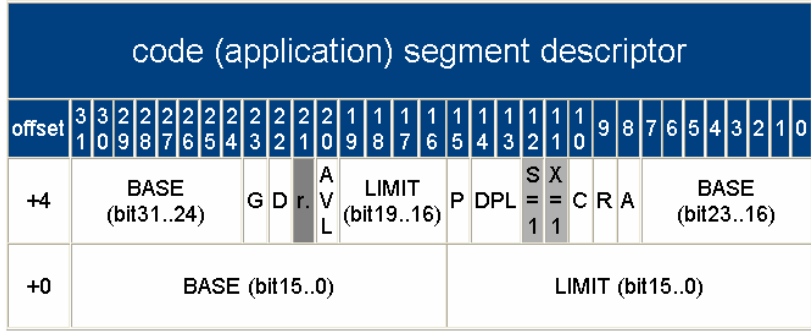

The 32bit base in both descriptors is scattered into different places because of compatibility reasons. The limit is stored in 20 bits but the G bit defines that the limit is in terms of bytes of 4K pages therefore a maximum of 4GB size is possible. The P bit must be set to signal that this segment is present in memory. DPL is the descriptor privilege level again related to the protection levels in 386. D bit defines that this segment is to execute code is 16bit mode or 32bit mode. C is conforming bit that we will not be using. R signals that the segment is readable. A bit is automatically set whenever the segment is accessed. The combination of S (system) and X (executable) tell that the descriptors is a code or a data descriptor. B (big) bit tells that if this data segment is used as stack SP is used or ESP is used.

Our first example is a very rudimentary one that just goes into protected mode and prints an A on the screen by directly accessing 000B8000.

Example 15.1	
001	[org 0x0100]
002	jmp start
003	
004	gdt: dd 0x00000000, 0x00000000 ; null descriptor
005	dd 0x0000FFFF, 0x00CF9A00 ; 32bit code
006	; \--/\--/ \ \ \ \ \
007	; +--- Base (16..23)=0 fill later
008	; +--- X=1 C=0 R=1 A=0
009	; +--- P=1 DPL=00 S=1
010	; +--- Limit (16..19) = F
011	; +--- G=1 D=1 r=0 AVL=0

```

012 ; | | +--- Base (24..31) = 0
013 ; | +--- Limit (0..15) = FFFF
014 ; +--- Base (0..15)=0 fill later
015 dd 0x0000FFFF, 0x00CF9200 ; data
016 ; \--/\--/ \/|||\|\/
017 ; | | | | +--- Base (16..23) = 0
018 ; | | | | +--- X=0 E=0 W=1 A=0
019 ; | | | | +--- P=1 DPL=00 S=1
020 ; | | | | +--- Limit (16..19) = F
021 ; | | | | +--- G=1 B=1 r=0 AVL=0
022 ; | | | | +--- Base (24..31) = 0
023 ; | | | | +--- Limit (0..15) = FFFF
024 ; | | | | +--- Base (0..15) = 0
025
026 gdtreg: dw 0x17 ; 16bit limit
027 dd 0 ; 32bit base (filled later)
028
029 stack: times 256 dd 0 ; for use in p-mode
030 stacktop:
031
032 start: mov ax, 0x2401
033 int 0x15 ; enable A20
034
035 xor eax, eax
036 mov ax, cs
037 shl eax, 4
038 mov [gdt+0x08+2], ax
039 shr eax, 16
040 mov [gdt+0x08+4], al ; fill base of code desc
041
042 xor edx, edx
043 mov dx, cs
044 shl edx, 4
045 add edx, stacktop ; edx = stack top for p-
046 mode
047
048 xor eax, eax
049 mov ax, cs
050 shl eax, 4
051 add eax, gdt
052 mov [gdtreg+2], eax ; fill phy base of gdt
053 lgdt [gdtreg] ; load gdt
054
055 mov eax, cr0
056 or eax, 1
057
058 cli ; MUST disable interrupts
059 mov cr0, eax ; P-MODE ON
060 jmp 0x08:pstart ; load cs
061
062 ;;;; 32bit protected mode ;;;;
063
064 [bits 32] ; ask assembler to generate 32bit code
065 pstart: mov eax, 0x10
066 mov ds, ax
067 mov es, ax ; load other seg regs
068 mov fs, ax ; flat memory model
069 mov gs, ax
070 mov ss, ax
071 mov esp, edx
072
073 mov byte [0x000b8000], 'A' ; direct poke at video
074 jmp $ ; hang around
075

```

Gate A20 is a workaround for a bug that is not detailed here. The BIOS call will simply enable it to open the whole memory for us. Another important thing is that the far jump we used loaded 8 into CS but CS is now a selector so it means Index=1, TI=0, and RPL=0 and therefore the actual descriptor loaded is the one at index 1 in the GDT.

15.2. 32BIT PROGRAMMING

Our next example is to give a favour of 32bit programming. We have written the printstr function for read and for protected mode. The availability of larger registers and flexible addressing rules allows writing a much comprehensive version of the code. Also offsets to parameters and default widths change.

Example 15.2	
001	[org 0x0100]
002	jmp start
003	
004	gdt: dd 0x00000000, 0x00000000 ; null descriptor
005	dd 0x0000FFFF, 0x00CF9A00 ; 32bit code
006	dd 0x0000FFFF, 0x00CF9200 ; data
007	
008	gdtreg: dw 0x17 ; 16bit limit
009	dd 0 ; 32bit base
010	
011	rstring: db 'In Real Mode...', 0
012	pstring: db 'In Protected Mode...', 0
013	
014	stack: times 256 dd 0 ; 1K stack
015	stacktop:
016	
017	printstr: push bp ; real mode print string
018	mov bp, sp
019	push ax
020	push cx
021	push si
022	push di
023	push es
024	
025	mov di,[bp+4] ;load string address
026	mov cx,0xffff ;load maximum possible size in cx
027	xor al,al ;clear al reg
028	repne scasb ;repeat scan
029	mov ax,0xffff ;
030	sub ax,cx ;calculate length
031	dec ax ;off by one, as it includes zero
032	mov cx,ax ;move length to counter
033	
034	mov ax, 0xb800
035	mov es, ax ; point es to video base
036	mov ax,80 ;its a word move, clears ah
037	mul byte [bp+8] ;its a byte mul to calc y offset
038	add ax,[bp+10] ;add x offset
039	shl ax,1 ;mul by 2 to get word offset
040	mov di,ax ;load pointer
041	
042	mov si, [bp+4] ; string to be printed
043	mov ah, [bp+6] ; load attribute
044	
045	cld ; set auto increment mode
046	nextchar: lods b ;load next char and inc si by 1
047	stos w ;store ax and inc di by 2
048	loop nextchar
049	
050	pop es
051	pop di
052	pop si
053	pop cx
054	pop ax
055	pop bp
056	ret 8
057	
058	start: push byte 0 ; 386 can directly push
059	immediates
060	push byte 10
061	push byte 7
062	push word rstring
063	call printstr
064	

```

065     mov ax, 0x2401
066     int 0x15             ; enable a20
067
068     xor eax, eax
069     mov ax, cs
070     shl eax, 4
071     mov [gdt+0x08+2], ax
072     shr eax, 16
073     mov [gdt+0x08+4], al     ; set base of code desc
074
075     xor edx, edx
076     mov dx, cs
077     shl edx, 4
078     add edx, stacktop     ; stacktop to be used in p-mode
079
080     xor ebx, ebx
081     mov bx, cs
082     shl ebx, 4
083     add ebx, pstring     ; pstring to be used in p-mode
084
085     xor eax, eax
086     mov ax, cs
087     shl eax, 4
088     add eax, gdt
089     mov [gdtreg+2], eax     ; set base of gdt
090     lgdt [gdtreg]         ; load gdt
091
092     mov eax, cr0
093     or  eax, 1
094
095     cli                   ; disable interrupts
096     mov cr0, eax         ; enable protected mode
097     jmp 0x08:pstart     ; load cs
098
099     ;;;; 32bit protected mode ;;;;
100
101     [bits 32]
102     pprintstr:  push ebp             ; p-mode print string routine
103                 mov  ebp, esp
104                 push eax
105                 push ecx
106                 push esi
107                 push edi
108
109                 mov  edi, [ebp+8] ;load string address
110                 mov  ecx, 0xffffffff ;load maximum possible size in cx
111                 xor  al, al      ;clear al reg
112                 repne scasb     ;repeat scan
113                 mov  eax, 0xffffffff ;
114                 sub  eax, ecx     ;calculate length
115                 dec  eax         ;off by one, as it includes zero
116                 mov  ecx, eax     ;move length to counter
117
118                 mov  eax, 80     ;its a word move, clears ah
119                 mul  byte [ebp+16] ;its a byte mul to calc y
120     offset
121                 add  eax, [ebp+20] ;add x offset
122                 shl  eax, 1     ;mul by 2 to get word offset
123                 add  eax, 0xb8000
124                 mov  edi, eax     ;load pointer
125
126                 mov  esi, [ebp+8] ; string to be printed
127                 mov  ah, [ebp+12] ; load attribute
128
129
130     pnextchar:  cld                 ; set auto increment mode
131                 lodsb             ;load next char and inc si by 1
132                 stosw            ;store ax and inc di by 2
133                 loop pnextchar
134
135                 pop  edi
136                 pop  esi
137                 pop  ecx
138                 pop  eax
139                 pop  ebp
140                 ret  16           ; 4 args now mean 16 bytes
141

```

```

142      pstart:      mov  ax, 0x10          ; load all seg regs to 0x10
143                      mov  ds, ax          ; flat memory model
144                      mov  es, ax
145                      mov  fs, ax
146                      mov  gs, ax
147                      mov  ss, ax
148                      mov  esp, edx        ; load saved esp on stack
149
150                      push byte 0
133                      push byte 11
134                      push byte 7
135                      push ebx
136                      call pprintstr      ; call p-mode print string
137      routine
138
139                      mov  eax, 0x000b8000
140                      mov  ebx, '/-\\|'
141
142      nextsymbol:  mov  [eax], bl
143                      mov  ecx, 0x00FFFFFF
144                      loop $
145                      ror  ebx, 8
146                      jmp  nextsymbol

```

15.3. VESA LINEAR FRAME BUFFER

As an example of accessing a really large area of memory for which protected mode is a necessity, we will be accessing the video memory in high resolution and high color graphics mode where the necessary video memory is alone above a megabyte. We will be using the VESA VBE 2.0 for a standard for these high resolution modes.

VESA is the Video Electronics Standards Association and VBE is the set of Video BIOS Extensions proposed by them. The VESA VBE 2.0 standard includes a linear frame buffer mode that we will be using. This mode allows direct access to the whole video memory. Some important VESA services are listed below.

```

INT 10 - VESA - Get SuperVGA Information
AX = 4F00h
ES:DI -> buffer for SuperVGA information
Return:
AL = 4Fh if function supported
AH = status

INT 10 - VESA - Get SuperVGA Mode Information
AX = 4F01h
CX = SuperVGA video mode
ES:DI -> 256-byte buffer for mode information
Return:
AL = 4Fh if function supported
AH = status
ES:DI filled if no error

INT 10 - VESA - Set VESA Video Mode
AX = 4F02h
BX = new video mode
Return:
AL = 4Fh if function supported
AH = status

```

One of the VESA defined modes is 8117 which is a 1024x768 mode with 16bit color and a linear frame buffer. The 16 color bits for every pixel are organized in 5:6:5 format with 5 bits for red, 6 for green, and 5 for blue. This makes 32 shades of red and blue and 64 shades of green and 64K total

possible colors. The 32bit linear frame buffer base address is available at offset 28 in the mode information buffer. Our example will produce shades of green on the screen and clear them and again print them in an infinite loop with delays in between.

Example 15.3

```

001 [org 0x0100]
002         jmp  start
003
004 modeblock:  times 256 db 0
005
006 gdt:      dd  0x00000000, 0x00000000  ; null descriptor
007         dd  0x0000FFFF, 0x00CF9A00  ; 32bit code
008         dd  0x0000FFFF, 0x00CF9200  ; data
009
010 gdtreg:   dw  0x17                      ; 16bit limit
011         dd  0                          ; 32bit base
012
013 stack:   times 256 dd 0                  ; 1K stack
014 stacktop:
015
016 start:   mov  ax, 0x4f01                  ; get vesa mode information
017         mov  cx, 0x8117                  ; 1024*768*64K linear frame
018 buffer
019         mov  di, modeblock
020         int  0x10
021         mov  esi, [modeblock+0x28]      ; save frame buffer base
022
023         mov  ax, 0x4f02                  ; set vesa mode
024         mov  bx, 0x8117
025         int  0x10
026
027         mov  ax, 0x2401
028         int  0x15                      ; enable a20
029
030         xor  eax, eax
031         mov  ax, cs
032         shl  eax, 4
033         mov  [gdt+0x08+2], ax
034         shr  eax, 16
035         mov  [gdt+0x08+4], al          ; set base of code desc
036
037         xor  edx, edx
038         mov  dx, cs
039         shl  edx, 4
040         add  edx, stacktop             ; stacktop to be used in p-mode
041
042         xor  eax, eax
043         mov  ax, cs
044         shl  eax, 4
045         add  eax, gdt
046         mov  [gdtreg+2], eax          ; set base of gdt
047         lgdt [gdtreg]                ; load gdt
048
049         mov  eax, cr0
050         or   eax, 1
051
052         cli                          ; disable interrupts
053         mov  cr0, eax                  ; enable protected mode
054         jmp  0x08:pstart              ; load cs
055
056 ;;;; 32bit protected mode ;;;;
057
058 [bits 32]
059 pstart:  mov  ax, 0x10                  ; load all seg regs to 0x10
060         mov  ds, ax                    ; flat memory model
061         mov  es, ax
062         mov  fs, ax
063         mov  gs, ax
064         mov  ss, ax
065         mov  esp, edx                  ; load saved esp on stack
066
067 ll:     xor  eax, eax

```

```

068          mov  edi, esi
069          mov  ecx, 1024*768*2/4          ; divide by 4 as dwords
070          cld
071          rep  stosd
072
073          mov  eax, 0x07FF07FF
074          mov  ecx, 32                    ; no of bands
075          mov  edi, esi
076
077 12:       push ecx
078          mov  ecx, 768*16                ; band width = 32
079 lines
080          cld
081          rep  stosd
082
083          mov  ecx, 0x000FFFFFF          ; small wait
084          loop $
085          pop  ecx
086
087          sub  eax, 0x00410041
088          loop 12
089
090          mov  ecx, 0x0FFFFFFF          ; long wait
091          loop $
092          jmp  11
093

```

15.4. INTERRUPT HANDLING

Handling interrupts in protected mode is also different. Instead of the IVT at physical address 0 there is the IDT (interrupt descriptor table) located at physical address stored in IDTR, a special purpose register. The IDTR is also a 48bit register similar in structure to the GDTR and loaded with another special instruction LGDT. The format of the interrupt descriptor is as shown below.

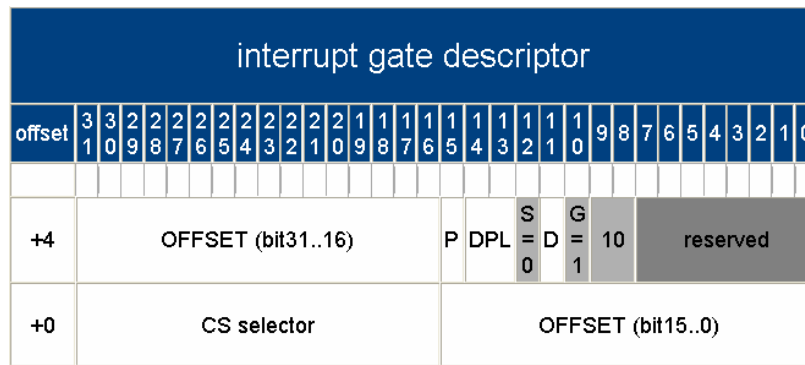

The P and DPL have the same meaning as in data and code descriptors. The S bit tells that this is a system descriptor while the 1110 following it tells that it is a 386 interrupt gate. Our example hooks the keyboard and timer interrupts and displays certain things on the screen to show that they are working.

Example 15.4	
001	[org 0x0100]
002	jmp start
003	
004	gdt: dd 0x00000000, 0x00000000 ; null descriptor
005	dd 0x0000FFFF, 0x00CF9A00 ; 32bit code
006	dd 0x0000FFFF, 0x00CF9200 ; data
007	
008	gdtreg: dw 0x17 ; 16bit limit
009	dd 0 ; 32bit base

```

010
011     idt:         times 8 dw 0x0008, 0x8e00, 0x0000
012                        dw  timer, 0x0008, 0x8e00, 0x0000
013                        \---/ \---/ ||\ \---/
014                        | | | +----- offset bits 16..32
015                        | | | +----- reserved
016                        | | | +----- Type=E 386 Interrupt Gate
017                        | | | +--- P=1 DPL=00 S=0
018                        | | | +----- selector
019                        +----- offset bits 0..15
020                        dw  keyboard, 0x0008, 0x8e00, 0x0000
021                        times 246 dw 0x0008, 0x8e00, 0x0000
022
023     idtreg:      dw  0x07FF
024                        dd  0
025
026     stack:       times 256 dd 0                ; 1K stack
027     stacktop:
028
029     start:       mov  ax, 0x2401
030                        int 0x15                ; enable a20
031
032                        xor  eax, eax
033                        mov  ax, cs
034                        shl  eax, 4
035                        mov  [gdt+0x08+2], ax
036                        shr  eax, 16
037                        mov  [gdt+0x08+4], al    ; set base of code desc
038
039                        xor  edx, edx
040                        mov  dx, cs
041                        shl  edx, 4
042                        add  edx, stacktop      ; stacktop to be used in p-mode
043
044                        xor  eax, eax
045                        mov  ax, cs
046                        shl  eax, 4
047                        add  eax, gdt
048                        mov  [gdtreg+2], eax    ; set base of gdt
049                        lgdt [gdtreg]          ; load gdtr
050
051                        xor  eax, eax
052                        mov  ax, cs
053                        shl  eax, 4
054                        add  eax, idt
055                        mov  [idtreg+2], eax    ; set base of idt
056
057                        cli                    ; disable interrupts
058                        lidt [idtreg]          ; load idtr
059
060                        mov  eax, cr0
061                        or   eax, 1
062                        mov  cr0, eax          ; enable protected mode
063
064                        jmp  0x08:pstart      ; load cs
065
066     ;;;; 32bit protected mode ;;;;
067
068     [bits 32]
069     unhandled:    iret
070
071     timer:        push eax
072
073                        inc  byte [0x000b8000]
074
075                        mov  al, 0x20
076                        out  0x20, al
077                        pop  eax
078                        iret
079
080     keyboard:     push eax
081
082                        in   al, 0x60
083                        mov  ah, al
084                        and  al, 0x0F
085                        shr  ah, 4

```

```

086         add ax, 0x3030
087         cmp al, 0x39
088         jbe skip1
089         add al, 7
090 skip1:   cmp ah, 0x39
091         jbe skip2
092         add ah, 7
093 skip2:   mov [0x000b809C], ah
094         mov [0x000b809E], al
095
096 skipkb:  mov al, 0x20
097         out 0x20, al
098         pop eax
099         iret
100
101 pstart:  mov ax, 0x10           ; load all seg regs to 0x10
102         mov ds, ax           ; flat memory model
103         mov es, ax
104         mov fs, ax
105         mov gs, ax
106         mov ss, ax
107         mov esp, edx        ; load saved esp on stack
108
109         mov al, 0xFC
110         out 0x21, al        ; no unexpected int comes
111
112         sti                 ; interrupts are okay now
113
114         jmp $

```

EXERCISES

- Write very brief and to-the-point answers.
 - Why loading idtr with a value appropriate for real mode is necessary while gdtr is not?
 - What should we do in protected mode so that when we turn protection off, we are in unreal mode?
 - If the line `jmp code:next` is replaced with `call code:somefun`, the prefetch queue is still emptied. What problem will occur when somefun will return?
 - How much is ESP decremented when an interrupt arrives. This depends on whether we are in 16-bit mode or 32-bit. Does it depend on any other thing as well? If yes, what?
 - Give two instructions that change the TR register.
- Name the following descriptors like code descriptor, data descriptor, interrupt gate etc.

```

gdt:  dd 0x00000000, 0x00000000
      dd 0x00000000, 0x00000000
      dd 0x80000FA0, 0x0000820b
      dd 0x0000ffff, 0x00409a00
      dd 0x80000000, 0x0001d20b

```

- Using the above GDT, which of the following values, when moved into DS will cause an exception and why.

```

0x00
0x08
0x10
0x18
0x28
0x23

```

- Using the above GDT, if DS contains 0x20, which of the following offsets will cause an exception on read access?

```

0x0ffff
0x10000
0x10001

```

5. The following function is written in 32-bit code for a 16-bit stack. Against every instruction, write the prefixes generated before that instruction. Prefixes can be address size, operand size, repeat, or segment override. Then rewrite the code such that no prefixes are generated considering that this is assembled and executed in 32-bit mode. Don't care for retaining register values. The function copies specified number of DWORDs between two segments.

```
[bits 32]
memcpy:    mov  bp, sp
           lds  esi, [bp+4]      ; source address
           les  edi, [bp+10]   ; destination address
           mov  cx, [bp+16]   ; count of DWORDs to move
           shl  cx, 1          ; make into count of WORDs
L1:        mov  dx, [si]
           mov  [es:di], dx
           dec  cx
           jnz  L1
           ret
```

6. Rewrite the following scheduler so that it schedules processes stored in readyQ, where enqueue and deque functions are redefined and readyQ contains TSS selectors of processes to be multitasked. Remember you can't use a register as a segment in a jump (eg jmp ax:0) but you can jump to an indirect address (eg jmp far [eax]) where eax points to a six-byte address. Declare any variables you need.

```

scheduler: mov  al, 0x20
           jmp  USERONESEL:0
           out  0x20, al
           mov  byte [USERONEDESC+5], 0x89
           jmp  USERTWOSEL:0
           out  0x20, al
           mov  byte [USERTWODESC+5], 0x89
           jmp  scheduler
```

7. Protected mode has specialized mechanism for multitasking using task state segments but the method used in real mode i.e. saving all registers in a PCB, selecting the next PCB and loading all registers from there is still applicable. Multitask two tasks in protected mode multitasking without TSS. Assume that all processes are at level zero so no protection issues arise. Be careful to save the complete state of the process.
8. Write the following descriptors.
- 32 bit, conforming, execute-only code segment at level 2, with base at 6MB and a size of 4MB.
 - 16 bit, non-conforming, readable code segment at level 0, with base at 1MB and a size of 10 bytes.
 - Read only data segment at level 3, with base at 0 and size of 1MB.
 - Interrupt Gate with selector 180h and offset 11223344h.
9. Write physical addresses for the following accesses where CS points to the first descriptor above, DS to the second, ES to the third, EBX contains 00010000h, and ESI contains 00020000h
- [bx+si]
 - [ebx+esi-2ffffh]
 - [es:ebx-10h]
10. Which of the following will cause exceptions and why. The registers have the same values as the last question.
- mov eax, [cs:10000h]
 - mov [es:esi:100h], ebx
 - mov ax, [es:ebx]
11. Give short answers.
- How can a GPF (General protection fault) occur while running the following code

```
push es
pop  es
```

Computer Architecture & Assembly Language Programming	Course Code: CS401
CS401@vu.edu.pk	VU

- b. How can a GPF occur during the following instruction? Give any two reasons.
- ```
jmp 10h:100h
```
- c. What will happen if we call interrupt 80h after loading out IDT and before switching to protected mode?
- d. What will happen if we call interrupt 80h after switching into protected mode but before making a far jump?
12. Write the following descriptors. Assume values for attributes not specifically mentioned.
- Write a 32-bit data segment with 1 GB base and 1 GB limit and a privilege level of 2.
  - Readable 16-bit code descriptor with 1 MB base and 1 MB limit and a privilege level of 1.
  - Interrupt gate given that the handler is at 48h:12345678h and a privilege level of 0.
13. Describe the following descriptors. Give their type and the value of all their fields.
- ```
dd 01234567h, 789abcdeh
dd 30405060h, 70809010h
dd 00aabb00h, 00ffee00h
```
14. Make an EXE file, switch into protected mode, rotate an asterisk on the border of the screen, and return to real mode when the border is traversed.

16

Interfacing with High Level Languages

16.1. CALLING CONVENTIONS

To interface an assembly routine with a high level language program means to be able to call functions back and forth. And to be able to do so requires knowledge of certain behavior of the HLL when calling functions. This behavior of calling functions is called the calling conventions of the language. Two prevalent calling conventions are the C calling convention and the Pascal calling convention.

What is the naming convention

C prepends an underscore to every function or variable name while Pascal translates the name to all uppercase. C++ has a weird name mangling scheme that is compiler dependent. To avoid it C++ can be forced to use C style naming with extern "C" directive.

How are parameters passed to the routine

In C parameters are pushed in reverse order with the rightmost being pushed first. While in Pascal they are pushed in proper order with the leftmost being pushed first.

Which registers must be preserved

Both standards preserve EBX, ESI, EDI, EBP, ESP, DS, ES, and SS.

Which registers are used as scratch

Both standards do not preserve or guarantee the value of EAX, ECX, EDX, FS, GS, EFLAGS, and any other registers.

Which register holds the return value

Both C and Pascal return upto 32bit large values in EAX and upto 64bit large values in EDX:EAX.

Who is responsible for removing the parameters

In C the caller removes the parameter while in Pascal the callee removes them. The C scheme has reasons pertaining to its provision for variable number of arguments.

16.2. CALLING C FROM ASSEMBLY

For example we take a function divide declared in C as follows.

```
int divide( int dividend, int divisor );
```

To call this function from assembly we have to write.

```
push dword [mydivisor]
```

Computer Architecture & Assembly Language Programming	Course Code: CS401
CS401@vu.edu.pk	VU

```

push dword [mydividend]
call _divide
add esp, 8
; EAX holds the answer

```

Observe the order of parameters according to the C calling conventions and observe that the caller cleared the stack. Now take another example of a function written in C as follows.

```

void swap( int* p1, int* p2 )
{
    int temp = *p1;
    *p1 = *p2;
    *p2 = temp;
}

```

To call it from assembly we have to write this.

```

[section .text]
extern _swap
x:          dd 4
y:          dd 7

push dword y
push dword x
call _swap ; will only retain the specified registers
add esp, 8

```

Observe how pointers were initialized appropriately. The above function swap was converted into assembly by the gcc compiler as follows.

```

; swap generated by gcc with no optimizations (converted to Intel
syntax)
; 15 instructions AND 13 memory accesses
_swap:
    push ebp
    mov    ebp, esp
    sub    esp, 4 ; space created for temp

    mov    eax, [ebp+8]
    mov    eax, [eax]
    mov    [ebp-4], eax ; temp = *p1

    mov    edx, [ebp+8]
    mov    eax, [ebp+12]
    mov    eax, [eax]
    mov    [edx], eax ; *p1 = *p2

    mov    edx, [ebp+12]
    mov    eax, [ebp-4]
    mov    [edx], eax ; *p2 = temp

    leave ;;;; EQUIVALENT TO mov esp, ebp AND pop ebp ;;;;
    ret

```

If we turn on optimizations the same function is compiled into the following code.

```

; generated with full optimization by gcc compiler
; 12 instructions AND 11 memory accesses
_swap:
    push    ebp
    mov     ebp, esp
    push    ebx

    mov     edx, [ebp+8]
    mov     ecx, [ebp+12]
    mov     ebx, [edx]
    mov     eax, [ecx]
    mov     [edx], eax
    mov     [ecx], ebx

    pop     ebx
    pop     ebp
    ret

```

16.3. CALLING ASSEMBLY FROM C

We now write a hand optimized version in assembly. Our version is only 6 instructions and 6 memory accesses.

Example 16.1	
001	[section .text]
002	global _swap
003	_swap: mov ecx,[esp+4] ; copy parameter p1 to ecx
004	mov edx,[esp+8] ; copy parameter p2 to edx
005	mov eax,[ecx] ; copy *p1 into eax
006	xchg eax,[edx] ; exchange eax with *p2
007	mov [ecx],eax ; copy eax into *p1
008	ret ; return from this function

We assemble the above program with the following command.

- `nasm -f win32 swap.asm`

This produces a swap.obj file. The format directive told the assembler that it is to be linked with a 32bit Windows executable. The linking process involves resolving imported symbols of one object files with export symbols of another. In NASM an imported symbol is declared with the extern directive while and exported symbol is declared with the global directive.

We write the following program in C to call this assembly routine. We should have provided the swap.obj file to the C linker otherwise an unresolved external symbol error will come.

Example 16.1	
001	#include <stdio.h>
002	
003	void swap(int* p1, int* p2);
004	
005	int main()
006	{
007	int a = 10, b = 20;
008	printf("a=%d b=%d\n", a, b);
009	swap(&a, &b);
010	printf("a=%d b=%d\n", a, b);
011	system("PAUSE");
012	return 0;
013	}

Computer Architecture & Assembly Language Programming	Course Code: CS401
CS401@vu.edu.pk	VU

EXERCISES

1. Write a traverse function in assembly, which takes an array, the number of elements in the array and the address of another function to be called for each member of the array. Call the function from a C program.
2. Make the linked list functions make in Exercise 5.XX available to C programs using the following declarations.

```

struct node {
    int data;
    struct node* next;
};
void init( void );
struct node* createlist( void );
void insertafter( struct node*, int );
void deleteafter( struct node* );
void deletelist( struct node* );

```

3. Add two functions to the above program implemented in C. The function “printnode” should print the data in the passed node using printf, while “countfree” should count the number of free nodes by traversing the free list starting from the node address stored in firstfree.

```

void printnode( struct node* );
void countfree( void );

```

4. Add the function “printlist” to the above program and implement in assembly. This function should traverse the list whose head is passed as parameter and for each node containing data (head is dummy and doesn't contain data) calls the C function printnode to actually print the contained data.

```

void printlist( struct node* );

```

5. Modify the createlist and deletelist functions in the above program to increment and decrement an integer variable “listcount” declared in C to maintain a count of linked lists present.

17

Comparison with Other Processors

We emphasized that assembly language has to be learned once and every processor can be programmed by that person. To give a flavour of two different widely popular processors we introduce the Motorola 68K series and the Sun SPARC processors. The Motorola 68K processors are very popular in high performance embedded applications while the Sun SPARC processors are popular in very high end enterprise servers. We will compare them with the Intel x86 series which is known for its success in the desktop market.

17.1. MOTOROLLA 68K PROCESSORS

Motorolla 68K processors are very similar to Intel x86 series in their architecture and instruction set. The both are of the same era and added various features at the same time. The instructions are very similar however the difference in architecture evident from a programmer's point of view must be understood.

68K processors have 16 23bit general purpose registers named from A0-A7 and D0-D7. A0-A7 can hold addresses in indirect memory accesses. These can also be used as software stack pointers. Stack in 68K is not as rigid a structure as it is in x86. There is a 32bit program counter (PC) that holds the address of currently executing instruction. The 8bit condition code register (CCR) holds the X (Extend) N (Negative) Z (Zero) V (Overflow) C (Carry) flags. X is set to C for extended operations (addition, subtraction, or shifting).

Motrola processors allow bit addressing, that is a specific bit in a byte or a bit field, i.e. a number of bits can be directly accessed. This is a very useful feature especially in control applications. Other data types include byte, word, long word, and quad word. A special MOVE16 instruction also accepts a 16byte block.

68K allows indirect memory access using any A register. A special memory access allows post increment or predecrement as part of memory access. These forms are written as (An), (An)+, and -(An). Other forms allow addressing with another register as index and with constant displacement. Using one of the A registers as the stack pointer and using the post increment and pre decrement forms of addressing, stack is implemented. Immediates can also be given as arguments and are preceded with a hash sign (#). Addressing is indicated with parenthesis instead of brackets.

68K has no segmentation; it however has a paged memory model. It used the big endian format in contrast to the little endian used by the Intel processors. It has varying instruction lengths from 1-11 words. It has a decrementing stack just like the Intel one. The format of instructions is "operation source, destination" which is different from the Intel order of operands. Some instructions from various instruction groups are given below.

Data Movement

```
EXG D0, D2
```

```
MOVE.B (A1), (A2)
```

Computer Architecture & Assembly Language Programming	Course Code: CS401
CS401@vu.edu.pk	VU

```

MOVEA (2222).L, A4
MOVEQ #12, D7
Arithmetic
ADD D7, (A4)
CLR (A3)           (set to zero)
CMP (A2), D1
ASL, ASR, LSL, LSR, ROR, ROL, ROXL, ROXR (shift operations)
Program Control
BRA label
JMP (A3)
BSR label         (CALL)
JSR (A2)         (indirect call)
RTD #4           (RET N)
Conditional Branch
BCC              (branch if carry clear)
BLS              (branch if Lower or Same)
BLT              (branch if Less Than)
BEQ              (branch if Equal)
BVC              (branch if Overflow clear)

```

17.2. SUN SPARC PROCESSOR

The Sun SPARC is a very popular processing belonging to the RISC (reduced instruction set computer) family of processors. RISC processors originally named because of the very few rudimentary instructions they provided, are now providing almost as many instruction as CISC (complex instruction set computer). However some properties like a fixed instruction size and single clock execution for most instructions are there.

SPARC stands for Scalable Processor ARChitecture. SPARC is a 64bit processor. Its byte order is user settable and even on a per program basis. So one program may be using little endian byte order and another may be using big endian at the same time. Data types include byte, Halfword, Word (32bit), and Double Word (64bits) and Quadword. It has a fixed 32bit instruction size. It has a concept of ASI (Address Space Identifier); an 8bit number that works similar to a segment.

There are 8 global registers and 8 alternate global registers. One of them is active at a time and accessible as g0-g7. Apart from that it has 8 in registers (i0-i7), 8 local registers (l0-l7), and 8 out registers (o0-o7). All registers are 64bit in size. The global registers can also be called r0-r7, in registers as r8-r15, local registers as r16-r23, and out registers as r24-r31.

SPARC introduces a concept of register window. One window is 24 registers and the active window is pointed to by a special register called Current Window Pointer (CWP). The actual number of registers in the processor is in hundreds not restricted by the architecture definition. Two instruction SAVE and RESTORE move this register window forward and backward by 16 registers. Therefore one SAVE instruction makes the out register the in registers and brings in new local and out registers. A RESTORE instruction makes the in registers out registers and restores the old local and in registers. This way parameters passing and returning can be totally done in registers and there is no need to save and restore registers inside subroutines.

The register o6 is conventionally used as the stack pointer. Return address is stored in o7 by the CALL instruction. The register g0 (r0) is always 0 so loading 0 in a register is made easy. SPARC is a totally register based architecture, or it is called a load-store architecture where memory access is only allowed in data movement instruction. Rest of the operations must be done on registers.

SPARC instructions have two sources and a distinct destination. This allows more flexibility in writing programs. Some examples of instructions of this processor follow.

Data Movement

LDSB [rn], rn (load signed byte)
LDUW [rn], rn (load unsigned word)
STH [rn], rn (store half word)

Arithmetic

source1 = rn
source2 = rn or simm13
dest = rn
ADD r2, r3, r4
SUB r2, 4000, r5
SLL, SRA, SRL (shifting)
AND, OR, XOR (logical)

Program Control

CALL (direct call)
JMPL (register indirect)
RET
SAVE
RESTORE
BA label (Branch Always)
BE label (branch if equal)
BCC label (branch if carry clear)
BLE label (branch if less or equal)
BVS label (branch if overflow set)